

**Jury Proceeding Addendum to COVID-19 Operating Plan for the  
Tarrant County Judiciary  
Effective on and after October 1, 2020**

Recognizing the need to ensure the health and safety of jurors, litigants, attorneys, visitors, court staff, judges, and other individuals entering the buildings housing the courts, the courts of Tarrant County will implement, in addition to the procedures and protocols in the previously submitted COVID-19 Operating Plan, the following protective measures for jury proceedings:

**General**

1. All judges will comply with the Emergency Orders issued by the Supreme Court of Texas and Court of Criminal Appeals, including conducting in-person jury proceedings according to the guidance issued by the Office of Court Administration.
2. The justice courts will not conduct an in-person jury proceeding until the Supreme Court permits such proceedings.
3. Judges of the district courts, constitutional and statutory county courts, and statutory probate courts will conduct in-person jury proceedings in accordance with the previously approved Operating Plan and this addendum only after this jury proceeding addendum is submitted and accepted by the Regional Presiding Judge.
4. Not more than five days before an approved in-person jury proceeding is scheduled to occur, the local administrative district judge or designee will consult with the local public health authority to verify that local health conditions and plan precautions are appropriate for the jury proceeding to proceed.
5. Except for criminal cases where confinement in jail or prison is a potential punishment, judges may conduct remote jury proceedings if the court follows the requirements of the hearings on objections or motions section below and ensures that all potential and selected petit jurors have access to technology to participate remotely. Judges may conduct remote jury proceedings in a criminal case where confinement in jail or prison is a potential punishment only with appropriate waivers and consent obtained on the record from the defendant and the prosecutor.

### Jury Proceeding Approval Process

1. Judges wishing to conduct a jury proceeding will follow the procedure detailed below to obtain approval to proceed with the jury proceeding from the local administrative district judge and Regional Presiding Judge.
2. Judges are required to present to the local administrative district judge, with a courtesy copy to the Regional Presiding Judge, a jury trial plan. Said plan shall include the case number and the style of the case. It shall further include an Auto CAD drawing of the court room where the trial and jury deliberations will take place. Said drawing shall indicate the seats or chairs where jurors as well as attorneys, litigants, witnesses, and court personnel will sit. Said plan shall include provisions for the qualification, voir dire, trial, and deliberations as well as where the jury will be sent during breaks in the trial. Said plan must take into consideration the provisions of COVID-19 Operating Plan for the Tarrant County Judiciary.
3. If local administrative district judge otherwise approves the plan, the local administrative district judge will forward the jury trial plan to the Regional Presiding Judge for approval. A trial judge may not proceed to trial without the approval of the local administrative district judge and the Regional Presiding Judge.
4. The local administrative district judge will, not more than five days before the jury proceeding, consult with the Tarrant County health authority to verify that the local health conditions and plan precautions are appropriate for the jury proceeding to proceed with the procedures as set forth below.

### Hearings on Objections or Motions Related to Proceeding

1. Parties who are scheduled for a jury proceeding are encouraged to make any objections or motions related to proceedings at least 10 days prior to the trial setting.
2. Any objections or motions related to proceeding with a jury proceeding will be heard by the judge presiding over the case at least seven days prior to the jury proceeding or as soon as practicable if the objection or motion is made or filed within seven days of the jury proceeding.

### Communication Protocols

1. Each judge with an approved in-person jury proceeding will require the parties to communicate with the court if any participant in the jury proceeding,

including attorneys, parties, attorney support staff, or witnesses, has tested positive for COVID-19 within the previous 30 days prior to any portion of the jury proceeding, currently has symptoms of COVID-19, or has had recent known exposure to COVID-19.

2. If the approved in-person jury proceeding involves an incarcerated participant, the judge will require the sheriff to report any positive COVID-19 test of the incarcerated participant within the previous 30 days prior to any portion of the jury proceeding, any current symptoms of COVID-19, or any recent known exposure to COVID-19.

### Scheduling

1. A judge who obtains approval for an in-person jury proceeding will schedule no more than ten cases for that jury trial setting, unless pre-approval for larger dockets is obtained from the Regional Presiding Judge.
2. Judges should attempt to alert parties who will not be proceeding prior to the day of trial to reduce attendance at the court facility.

### Summoning Jurors

1. The Tarrant County jury bailiff must include the Jury Service COVID-19 Pre-Screening Questionnaire (attached) with in-person juror summonses that elicit from prospective jurors information about their exposure or vulnerability to COVID-19.
2. Judges will consider using juror questionnaires for voir dire to assist in shortening the length of voir dire or the number of venirepersons.
3. Excuses or requests to reschedule from in-person prospective jurors who have been potentially exposed, who are symptomatic, and who are vulnerable or live with someone vulnerable to COVID-19 will be liberally granted.

### Location for Jury Selection, Trial, and Deliberation

1. The following locations have sufficient space to permit adequate social distancing and will be used for in-person jury proceedings:

- a. Jury Qualification:

Potential jurors may respond online as directed by the Tarrant County Jury Services website or may respond by appearing in person at the central jury room located in the Tim Curry Justice Center. The Tarrant County jury bailiff

will determine qualifications and exemptions and will reschedule jurors if necessary.

The Tarrant County jury bailiff and her staff will assure that the proper health precautions as set forth above in this addendum are followed in the central jury room.

Court staff and/or the jury bailiff's staff will assist potential jurors in their use of a secure entrance when entering the building, the central jury room or other approved locations, and the elevators transporting the jurors to the appropriate floor of the court building.

**b. Voir Dire:**

Voir dire for twelve person jury panels will be conducted in the central jury room of the Tim Curry Justice Center. The use of the Tarrant County Resource Connection Gymnasium, the Tom Vandergriff Civil Courts Building jury room, and the Family Law Center assembly room will be used only after approval from the County Administrator. The request to use these facilities must be made in the proposed jury trial plan. The local administrative district judge and not the trial judge will contact the County Administrator to schedule the use of these facilities. Any requested use of a facility other than rooms in county facilities must also be approved by the County Administrator. The local administrative district judge will also contact the County Administrator regarding those venues if, in the local administrative district judge's opinion, there are no appropriate or available rooms within county buildings.

Voir dire for six person jury panels will be conducted as set forth in the above paragraph regarding twelve person jury panels unless the court room is of sufficient size to conduct voir dire while maintaining the appropriate social distancing

**c. Trials:**

Trials will be held in the courtrooms if of sufficient load capacity to maintain appropriate social distancing. If the requesting judge requests in the proposed jury trial plan that a jury trial be held in the Charles Murray Courtroom in the Tom Vandergriff Civil Courts Building, the Tom Vandergriff Civil Courts Building jury room, or the Family Law Center assembly room, that

request must be approved the administrative judges and by the County Administrator. The local administrative district judge and not the trial judge will contact the County Administrator regarding the use of those facilities if the administrative judges agree the use of those facilities as requested in the jury trial plan would be necessary.

**d. Jury Deliberation:**

Jury deliberations will be held in a vacant or unused courtroom in the court building where the trial is held. If no vacant or unused courtrooms exist in the same building, jury deliberations will be held in a vacant or unused courtroom in another county courts building. If there are no vacant or unused courtrooms in the building where the trial is held, the requesting judge is to include the need for a vacant or unused courtroom in another courts building in the jury trial plan. The local administrative district judge will contact the appropriate county administrators in order to locate another vacant or unused courtroom in another county courts building.

**e. Security protocols at the locations for jury proceedings have been reviewed with the appropriate courthouse security personnel and are adequate for the proceeding.**

**Screening**

1. In addition to the requirements of the previously submitted in-person Operating Plan, all court participants and observers attending an in-person jury proceeding will be screened for elevated temperatures and will be questioned to determine if the individual has recently had symptoms of COVID-19 or been exposed to COVID-19.
2. All participants in a trial who are incarcerated will be screened by the jail/prison prior to transport to the courtroom and any known exposure, symptoms, or COVID-19 positive test results within the past 30 days will be reported to the judge presiding over the jury trial prior to the transport of the participant to the courtroom.

**Face Coverings**

1. In addition to the requirements of the previously submitted in-person Operating Plan, all persons entering the common areas of a courthouse, including a courtroom or any other location being used to conduct a jury trial, will be

required to wear a face covering at all times unless the person is an individual that is not recommended to wear a mask by the Centers for Disease Control or the Texas Department of State Health Services.

2. All court participants will be required to wear face coverings from jury qualification through the end of trial.
3. Court participants who may need to lower their face mask to speak or for a short period of time will be required to wear a face shield. When speaking, judges will permit a court participant to lower his or her mask so long as a face shield is worn, and the person speaking is immobile.

### Social Distancing

1. Social distancing of all court participants and observers will be maintained at all times during the jury proceeding, including during the trial and deliberation.
2. Special attention will be paid by courts to ensure adequate social distancing and managed exits of individuals during breaks, especially when dismissing large groups of people for a break.

### Alternate Jurors

1. Each judge with an approved in-person jury proceeding will be encouraged to consider selecting alternate jurors to permit the trial to continue in the event of a juror becoming ineligible to serve for a reason unrelated to that person's exposure to or contraction of COVID-19.

### Arrangement of Courtroom

1. The attached drawings detail how each of the courtrooms or facilities will be arranged during the jury proceeding:

Jurors will be seated in the jury box and/or in the gallery as determined by the judge with each juror being seated six feet apart to maintain appropriate social distancing. Plexiglass barriers will be installed between those jurors seated in the gallery and the observers or other attorneys, litigants, witnesses, court personnel, or observers who may also be seated in the gallery. Judges shall seat all participants including attorneys, litigants, witnesses, court personnel, the judge, and all jurors including alternate jurors according to the Auto CAD drawings attached hereto and required to be attached to the requesting judge's jury trial plan.

### Microphone Protection Protocols

1. Judges will limit, to the degree possible, the shared use of microphones during the jury proceeding.
2. If a microphone must be shared, judges will limit the passing of the microphone unless the microphone is cleaned between each user.
3. Disposable microphone covers will be placed on shared microphones and changed between each user.

### Exhibit/Evidence Management

1. Judges will limit, to the degree possible, the use of physical or paper exhibits/evidence where feasible or appropriate by converting the exhibit/evidence to a digital form.
2. When physical or paper exhibits/evidence is required, judges will reduce the exchange of that exhibit/evidence to the number of persons necessary and will limit passing the exhibit/evidence to the individual members of the jury.
3. If an exhibit/evidence is required to be transferred from person-to-person, single use gloves will be provided, worn, and discarded immediately after handling the exhibit/evidence.
4. During jury deliberations, judges will make efforts to provide the jury with access to digital exhibits/evidence that would normally be shared with the jury during deliberation. Where digital exhibits/evidence is not feasible, judges will consider limiting the transfer of the exhibits/evidence from juror-to-juror by spreading the exhibits/evidence on a table for inspection from the table in the jury deliberation room.

### Witnesses

1. Judges will inquire whether witnesses to the proceedings have COVID-related issues.
2. To the degree constitutionally permissible or with the consent of the parties, judges will permit witnesses to testify remotely via videoconference, especially if that witness has symptoms of or a recent positive test for COVID-19, has been recently exposed, or is vulnerable to contracting COVID-19.

### Food Precautions

1. Courts that provide food to jurors or other participants during a jury proceeding will ensure individual food portions, such as individually boxed meals, are provided.

### Cleaning

1. In addition to the requirements of the previously submitted in-person Operating Plan, frequent cleaning protocols in the courtrooms and facilities will be maintained throughout the jury proceeding as appropriate.
2. Shared spaces such as witness stands, seating in the gallery, and seating during qualification/voir dire will be cleaned during transitions of those spaces.
3. Seats for members of the jury panel and selected jurors will be assigned to reduce potential transmission and the need for more frequent cleaning.

I have attempted to confer with all judges of courts with courtrooms in the court building regarding the Jury Proceeding Addendum to the Operating Plan. In developing the plan, I consulted with the local health authority and county judge, documentation of which is attached to this plan. I will ensure that the judges of courts with courtrooms in the court building covered by this Operating Plan conduct proceedings consistent with the plan.

Date: 10/8/2020

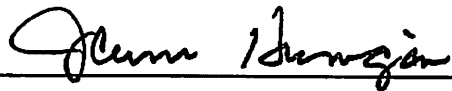
  
\_\_\_\_\_  
Local Administrative District Judge



## JURY SERVICE COVID-19 PRE-SCREENING QUESTIONNAIRE

Dear Prospective Juror:

As part of the court's ongoing measures to protect against the spread of the COVID-19 virus, we ask that you complete the following questionnaire before reporting for jury service. You may complete the questionnaire online or return it to Jury Services by mail or fax at least 2 days before your summons date. If you are unable to return the questionnaire before your summons date, complete it and bring it with you on your summons date.

**1. SYMPTOMS:** Check any that apply to YOU or A MEMBER OF YOUR HOUSEHOLD:

Fever (above 100.0°)  Change in taste, smell or appetite  Cough  Headache  Shortness of Breath  Diarrhea

Chills or repeated shaking with chills  Muscle pain or body aches  Sore throat

I certify that none of the symptoms above have been experienced by me or a member of my household within the last 14 days.

**IF YOU ARE EXPERIENCING ANY OF THE ABOVE SYMPTOMS, CONTACT JURY SERVICES  
BEFORE REPORTING ON THE SUMMONS DATE OR GO ONLINE TO DEFER SERVICE TO A LATER DATE.**

**2. CONTACT HISTORY:** Check any that apply to YOU or A MEMBER OF YOUR HOUSEHOLD:

I or a member of my household has been diagnosed with COVID-19 within the past 4 months;

I or a member of my household has been in close contact with someone exposed to or infected with COVID-19 in the last 14 days;

I or a member of my household are currently on a watch list or self-quarantining because of possible COVID-19 exposure;

NONE of the above apply.

**IF ANY OF THE ABOVE APPLY, CONTACT JURY SERVICES BEFORE REPORTING ON THE  
SUMMONS DATE OR GO ONLINE TO DEFER SERVICE TO A LATER DATE.**

**3. COVID-19 RELATED EXCUSE OR EXTENSION:** Individuals who are over age 65 and individuals with serious underlying health conditions, such as high blood pressure, chronic lung disease, diabetes, obesity, asthma, and those whose immune systems are compromised, such as by chemotherapy for cancer or other conditions requiring such therapy, are considered to be vulnerable populations and may request to reschedule or be excused from jury service at this time. If you wish to be excused or request that your jury service date be rescheduled, check the box below.

*I certify that I meet the above-described conditions and I am requesting to be excused from jury service or desire to have my service date rescheduled because of those conditions.*

**IF YOU ARE REQUESTING TO BE EXCUSED OR YOUR SERVICE DATE BE RESCHEDULED DUE TO A COVID-19 RELATED REASON, CONTACT JURY SERVICES BEFORE REPORTING ON YOUR SUMMONS DATE, OR GO ONLINE AND COMPLETE THE COVID-19 PRE-SCREENING QUESTIONNAIRE.**

**4. FACE COVERINGS:** Prospective jurors are required to wear a face covering while they are in the courthouse. Individuals are encouraged to bring a cloth face covering with them. If an individual does not have a cloth face covering, a disposable face mask will be provided.

I certify the above is true and correct:

\_\_\_\_\_  
Signature

\_\_\_\_\_  
Printed Name

\_\_\_\_\_  
Date

**Jury Services Contact Information**

Online: <https://eResponse.tarrantcounty.com>

Phone: 817-884-3820

Email: [juryroom@tarrantcounty.com](mailto:juryroom@tarrantcounty.com)

Mail or In Person: Tarrant County Jury Services  
401 W. Belknap Street  
Fort Worth, TX 76196

Fax: 817-850-2301

# TIM CURRY CRIMINAL JUSTICE CENTER

## Courtroom Group A

MAXIMUM SOCIAL DISTANCING OCCUPANCY LOAD IS 27

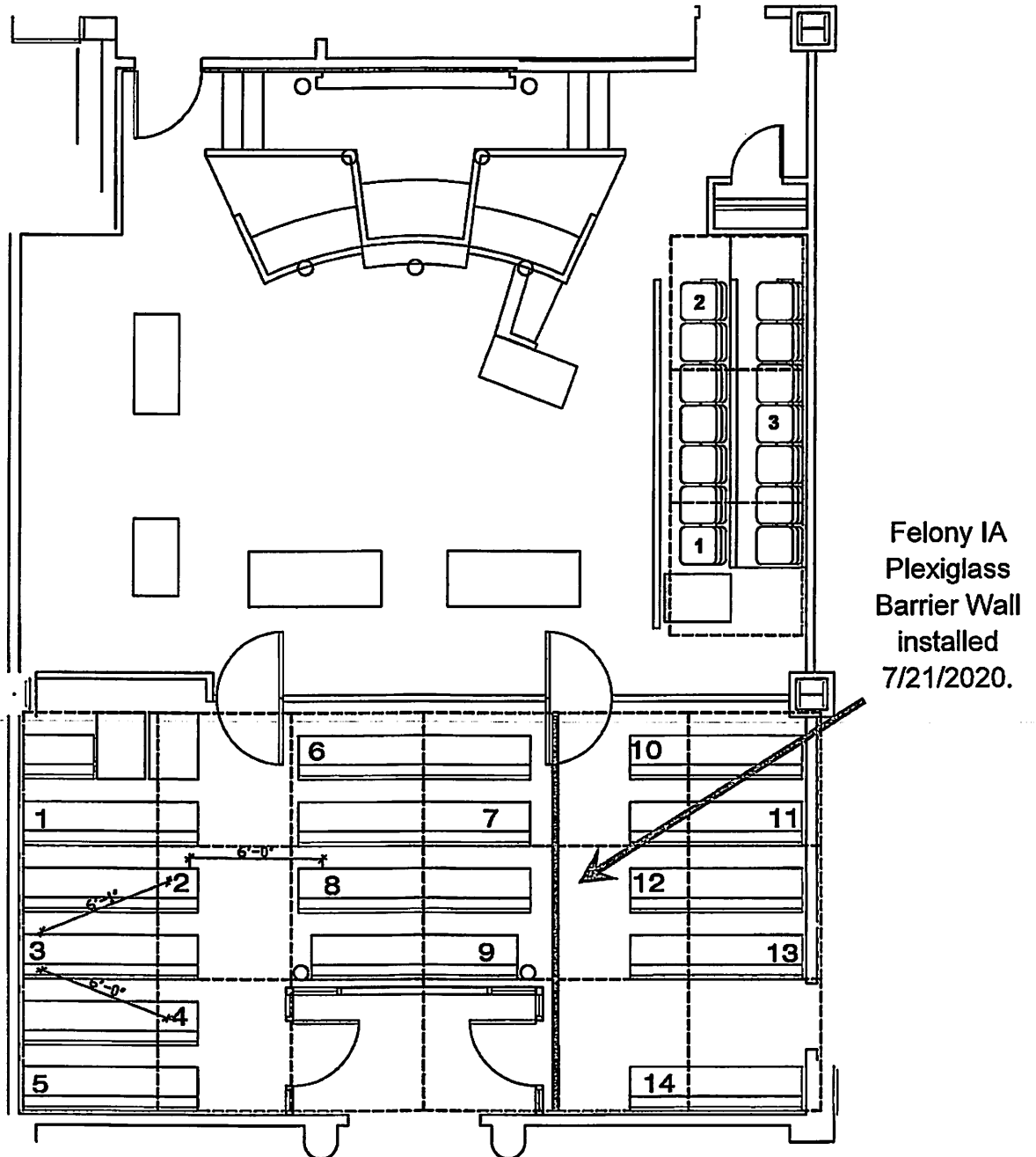

**5th Floor**  
 297th  
 CDC #1  
 CCC #1  
 CCC #4

**6th Floor**  
 372nd  
 396th  
 432nd  
 CCC #2  
 CCC #5  
 Voir Dire

**7th Floor**  
 Aux B  
 Aux C  
 CCC #3  
 CCC #8  
 CCC #10  
 Felony 1st Appearance

**8th Floor**  
 213th  
 371st  
 Aux A  
 CCC #6  
 CCC #7  
 TechShare

# TIM CURRY CRIMINAL JUSTICE CENTER

## Courtroom Group B

MAXIMUM SOCIAL DISTANCING OCCUPANCY LOAD IS 28

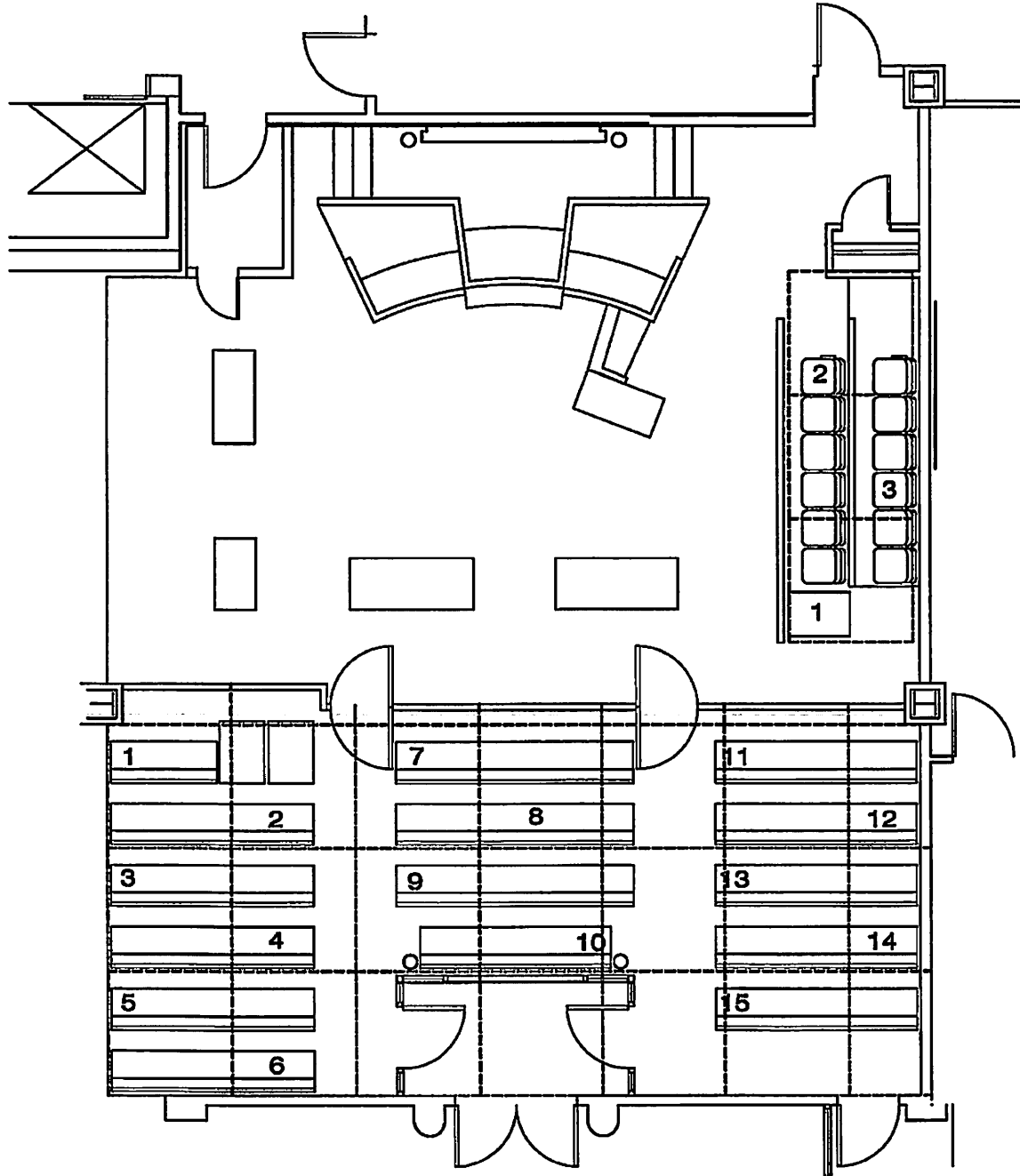

**6th Floor**

**CDC #2**

**7th Floor**

**CDC #3**

**8th Floor**

**CDC #4**

# TIM CURRY CRIMINAL JUSTICE CENTER

## Courtroom Group C

MAXIMUM SOCIAL DISTANCING OCCUPANCY LOAD IS 22

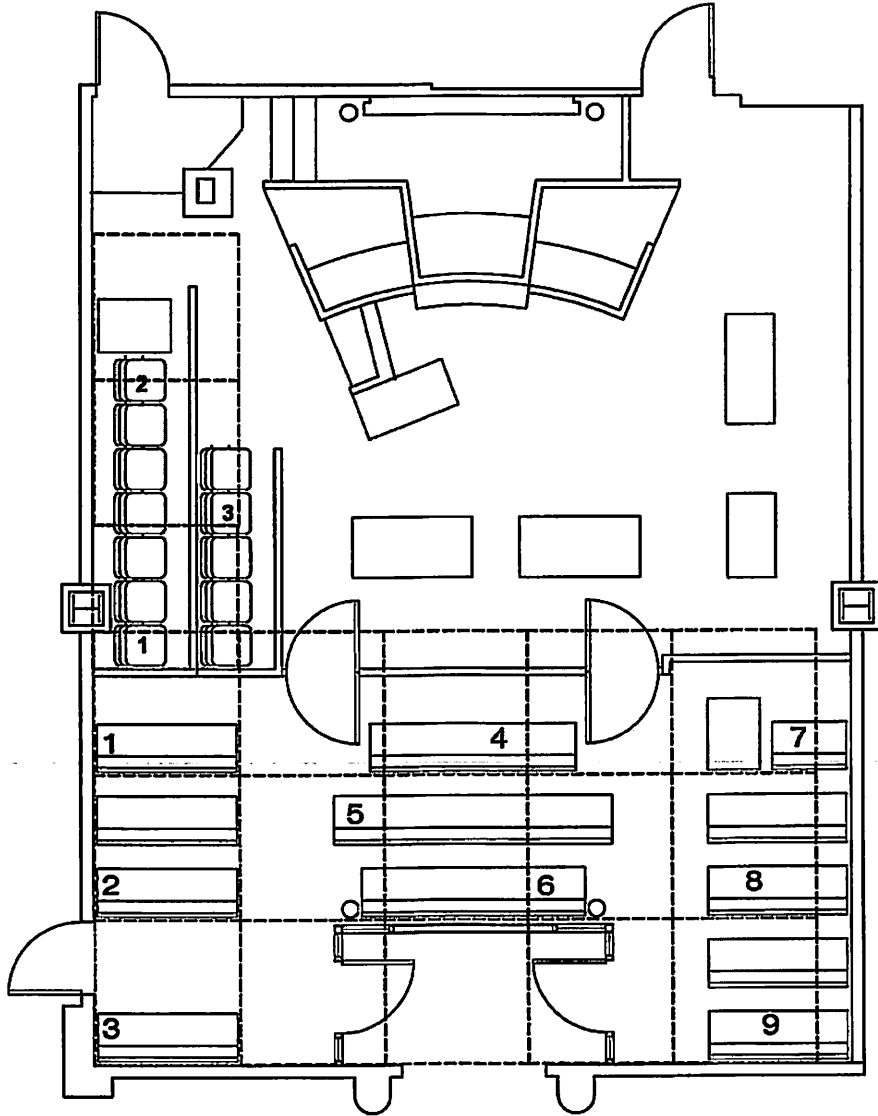

**6th Floor**

Aux E

**7th Floor**

Aux D

**8th Floor**

CCC #9

# TIM CURRY CRIMINAL JUSTICE CENTER

## North/South Jury Rooms

MAXIMUM SOCIAL DISTANCING OCCUPANCY LOAD IS 3

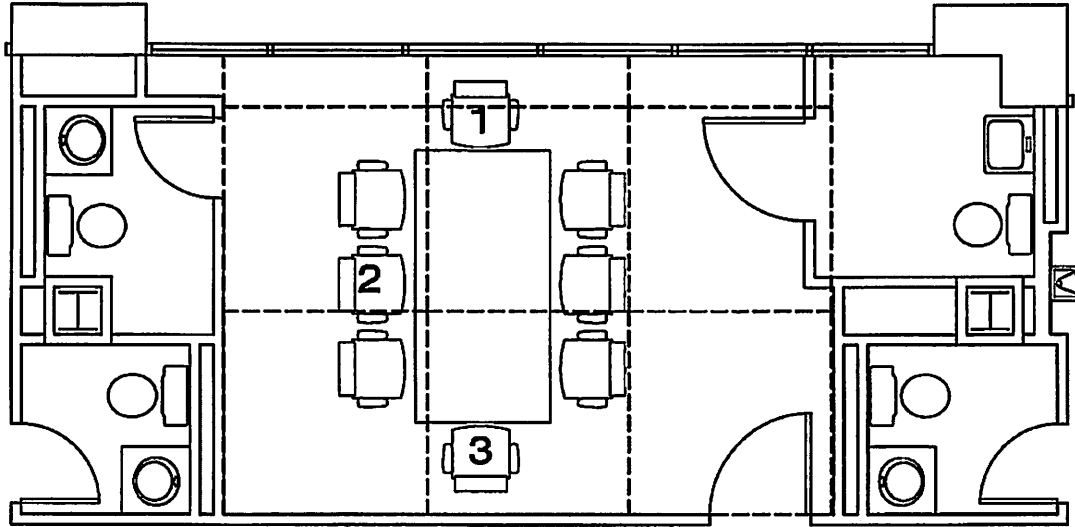

**5th Floor**  
CCC #1  
CCC #4

**6th Floor**  
Aux E  
372nd Dist. Ct.  
432nd Dist. Ct.  
CCC #2

**7th Floor**  
Aux B  
Aux C  
Aux D  
CCC #8

**8th Floor**  
213th Dist. Ct.  
CCC #7  
CCC #9  
TechShare

# TIM CURRY CRIMINAL JUSTICE CENTER

## East/West Jury Rooms

MAXIMUM SOCIAL DISTANCING OCCUPANCY LOAD IS 3

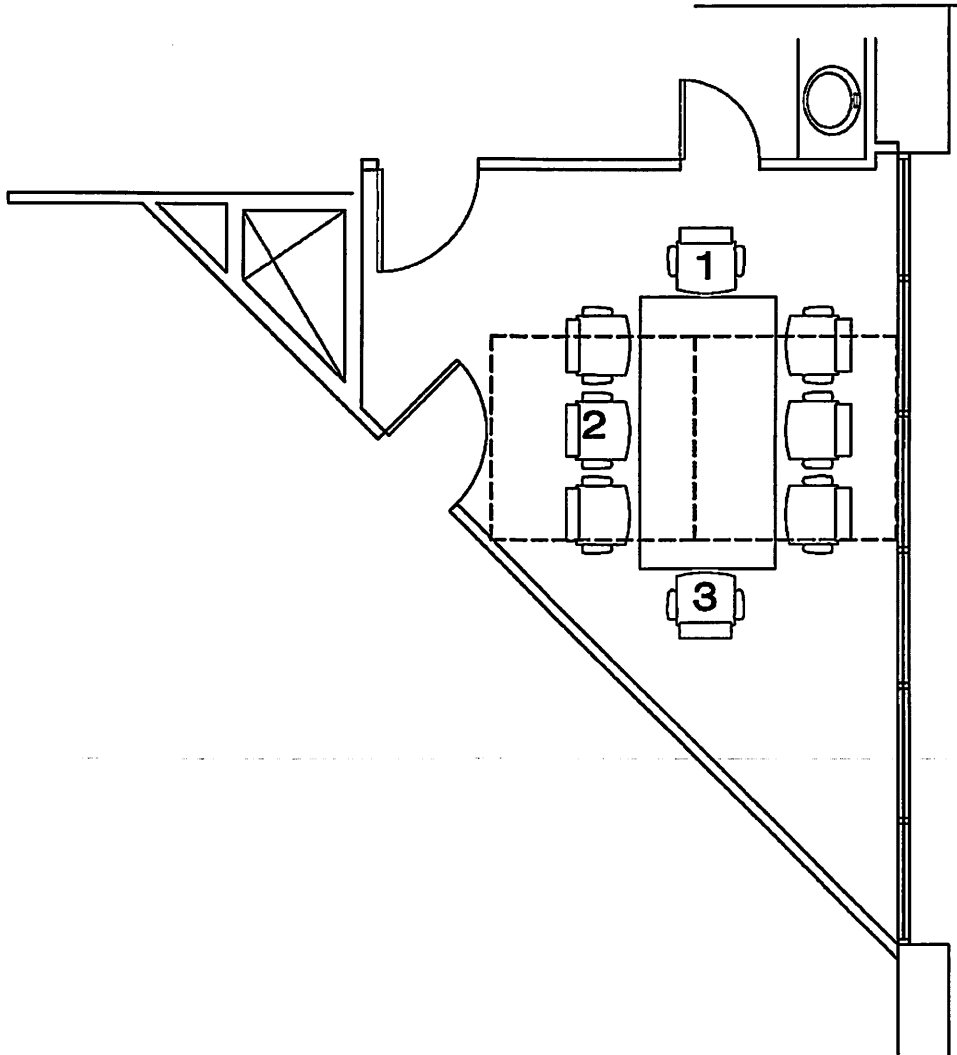

**5th Floor**  
297th  
CDC #1

**6th Floor**  
396th  
CCC #5  
CDC #2  
Voir Dire

**7th Floor**  
CCC #3  
CCC #10  
CDC #3  
Felony 1st Appearance

**8th Floor**  
371st  
Aux A  
CCC #6  
CDC #4

# TIM CURRY CRIMINAL JUSTICE CENTER

MAXIMUM SOCIAL DISTANCING OCCUPANCY LOAD IS 14

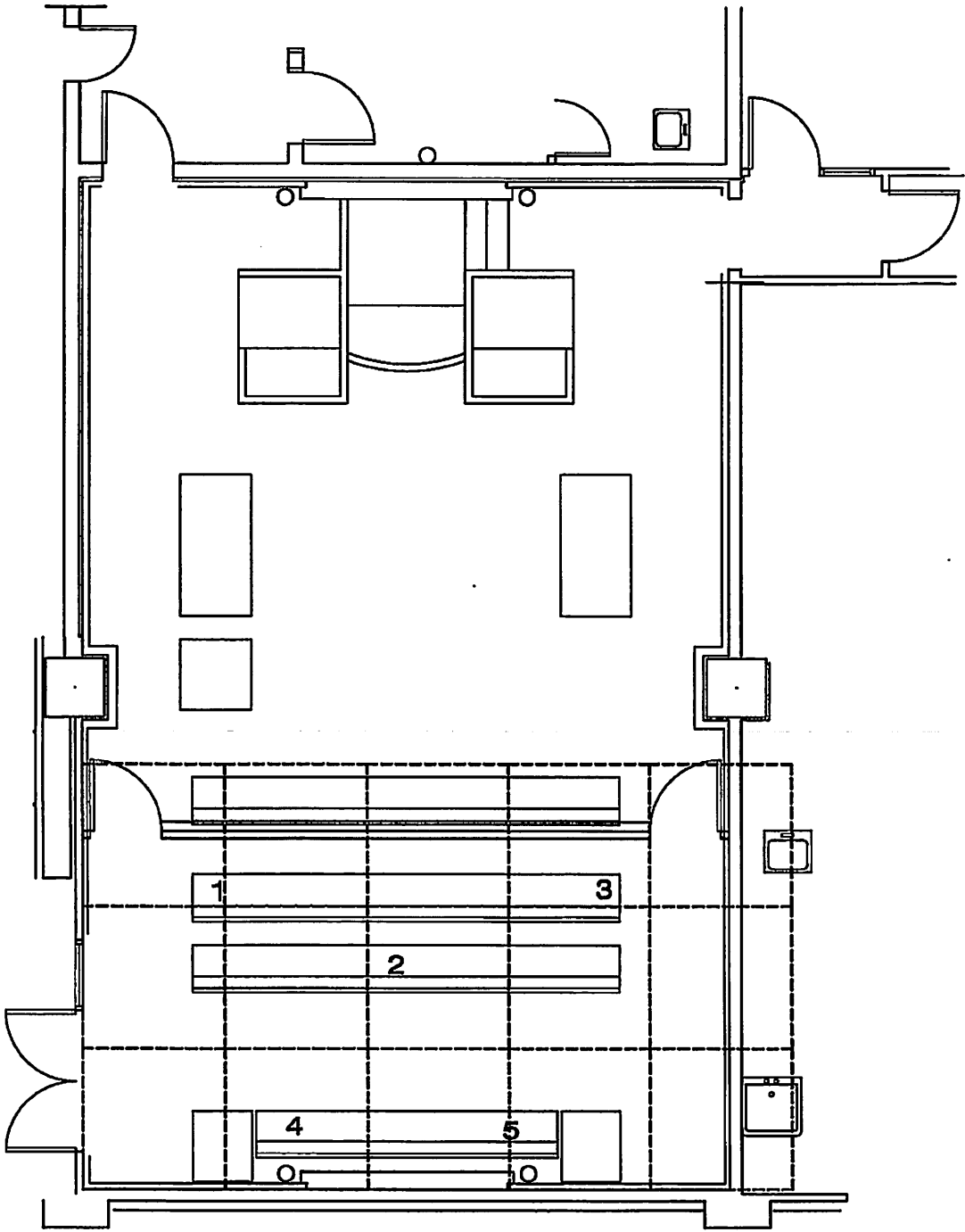

Magistrate  
Basement Level



# TIM CURRY CRIMINAL JUSTICE CENTER

MAXIMUM SOCIAL DISTANCING OCCUPANCY LOAD IS 89

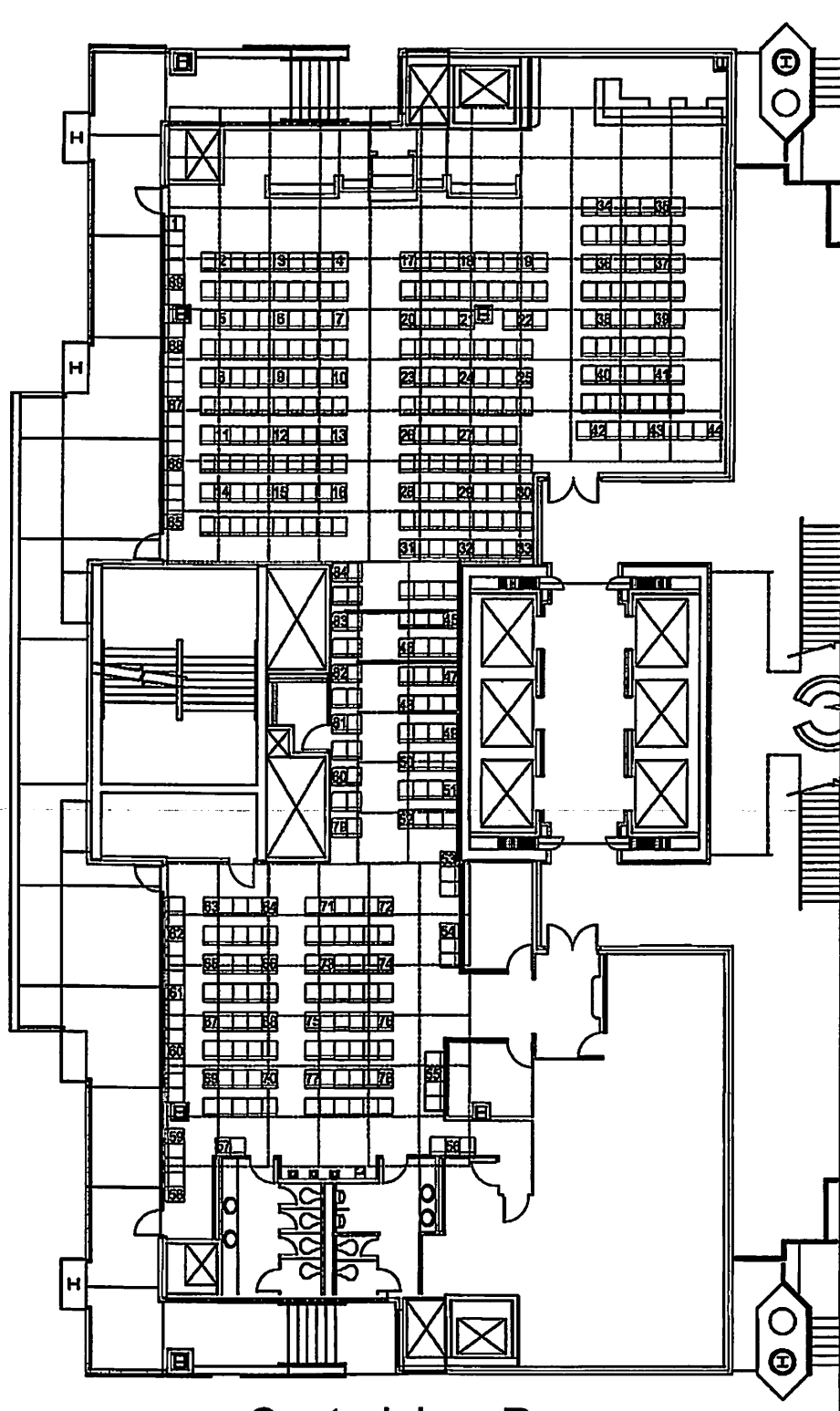

Central Jury Room  
Plaza Level

# FAMILY LAW CENTER

MAXIMUM SOCIAL DISTANCING OCCUPANCY LOAD IN COURTROOM IS 18

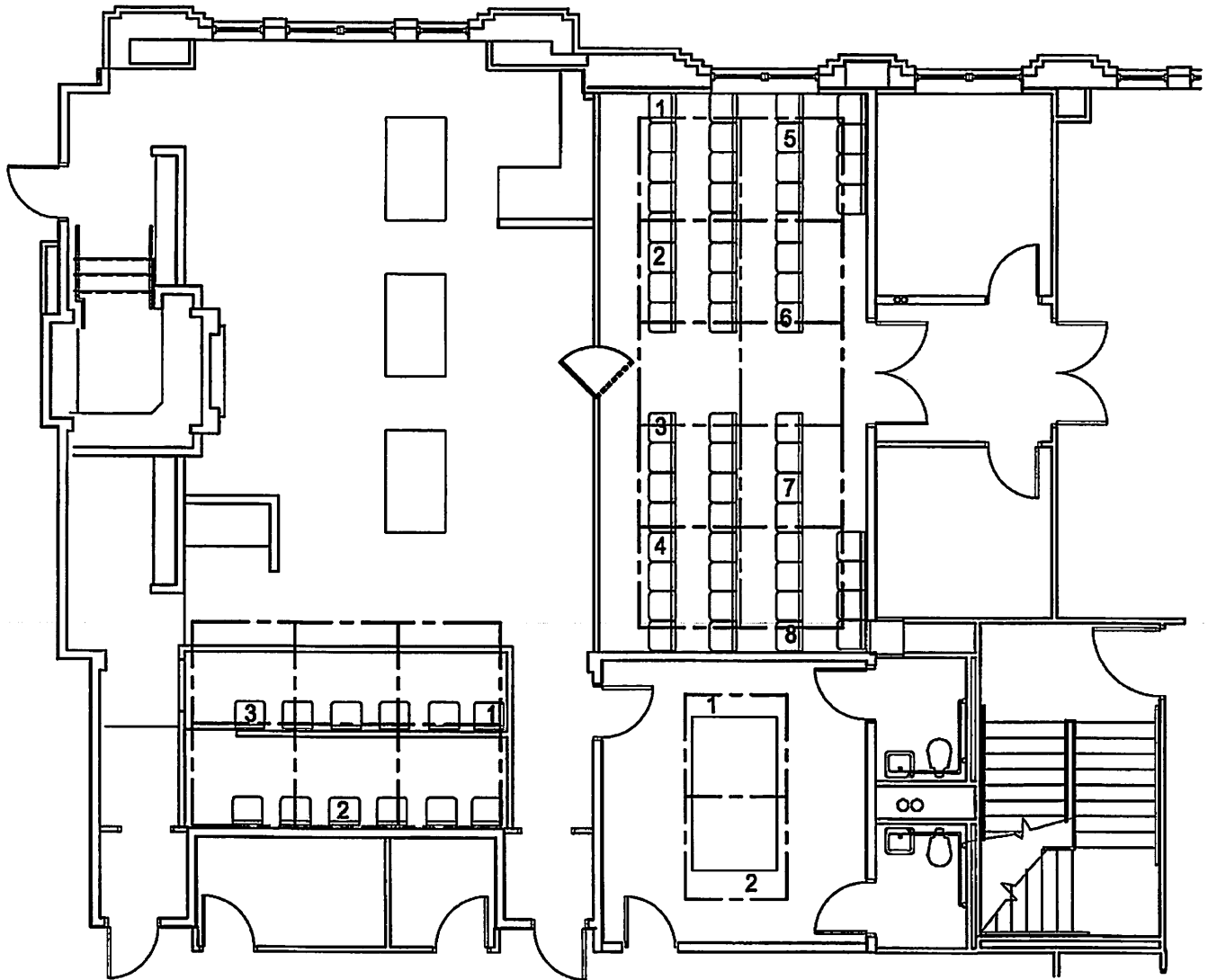

231st Dist. Court  
233rd Dist. Court  
322nd Dist. Court

324th Dist. Court  
325th Dist. Court  
360th Dist. Court

# FAMILY LAW CENTER

MAXIMUM SOCIAL DISTANCING OCCUPANCY LOAD IS 14

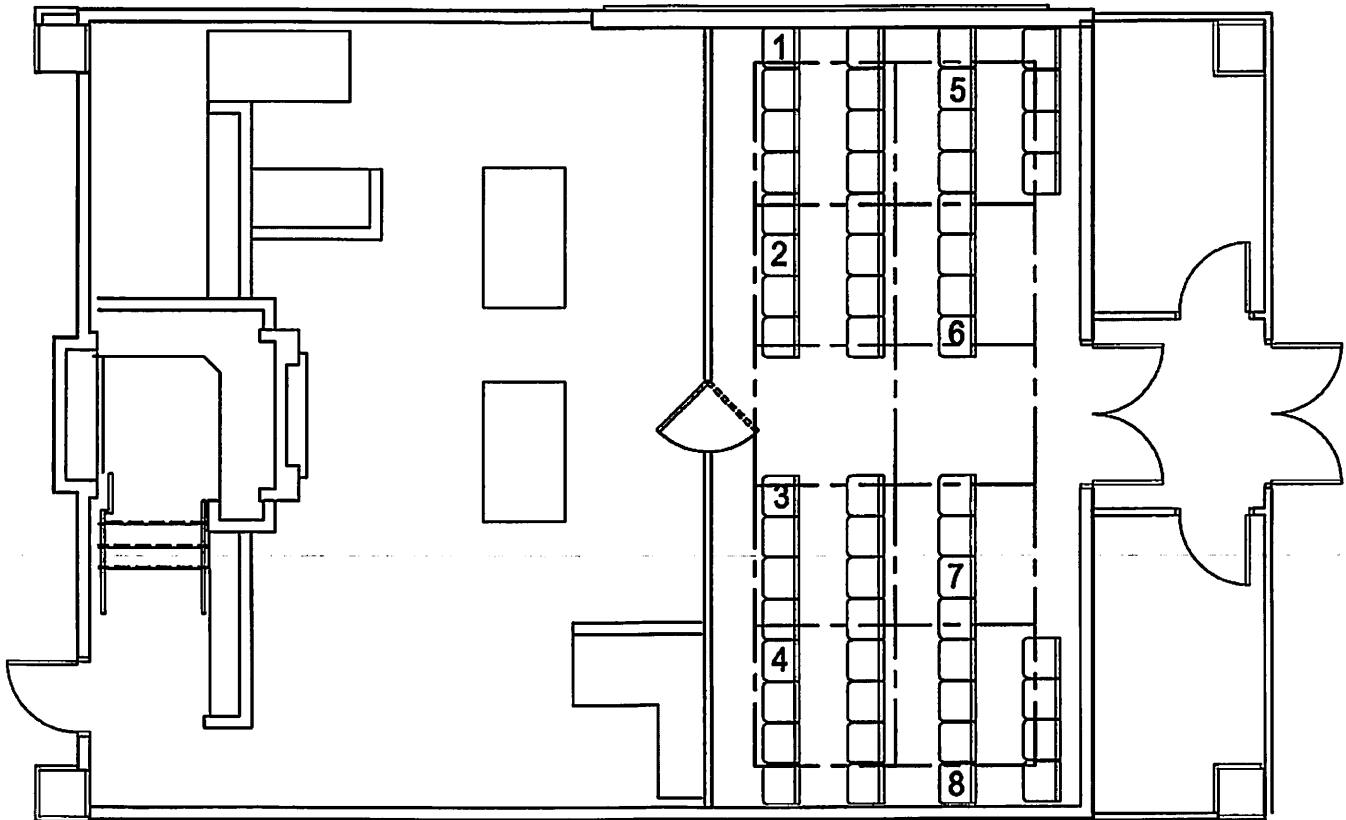

IV-D Courts  
231st Assoc. Court  
233rd Assoc. Court  
322nd Assoc. Court

324th Assoc. Court  
325th Assoc. Court  
360th Assoc. Court  
Child Protection Court

# FAMILY LAW CENTER

MAXIMUM SOCIAL DISTANCING OCCUPANCY LOAD IS 40

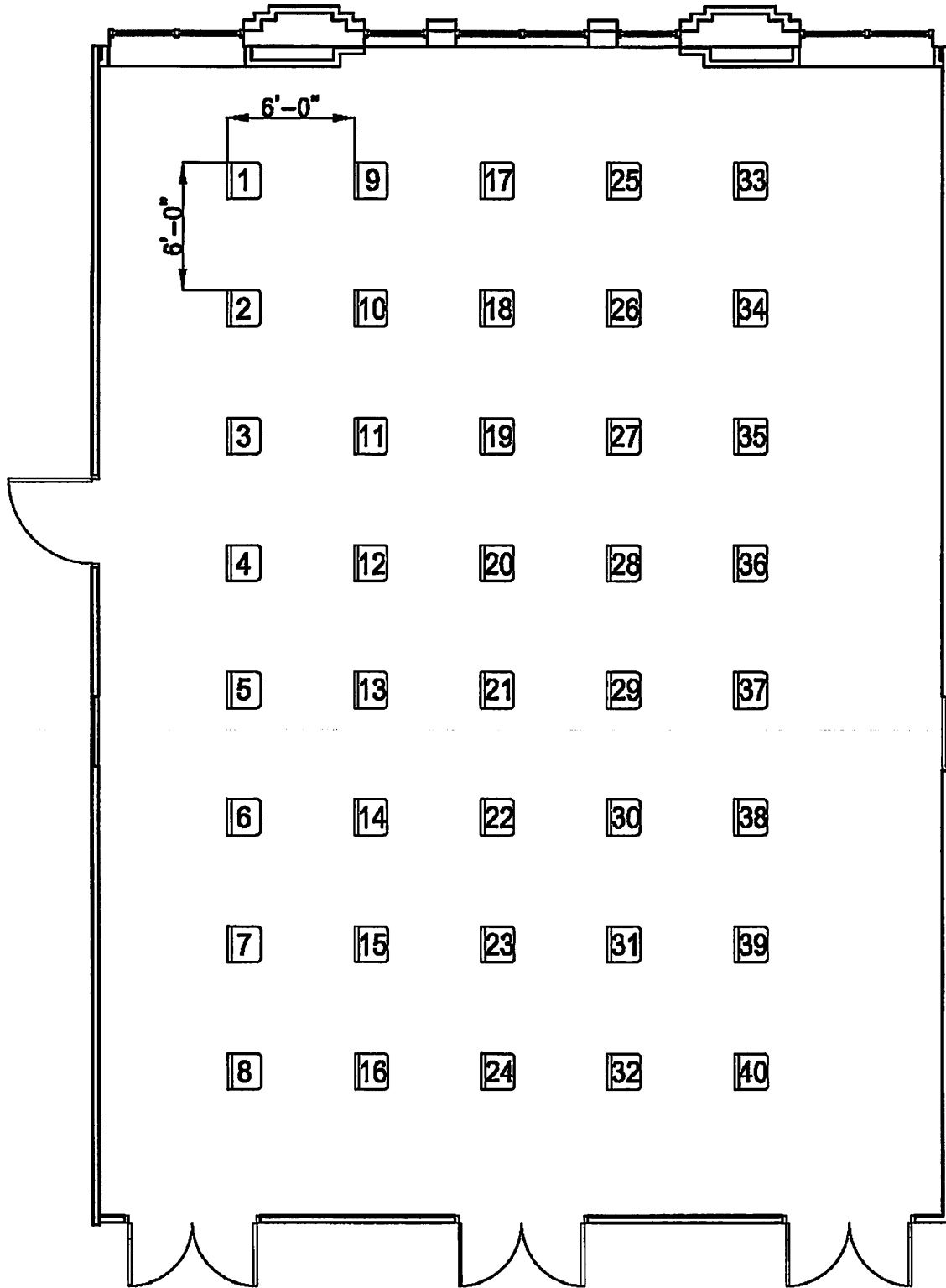

2nd Floor Assembly Room

# TOM VANDERGRIF CIVIL COURTS BUILDING

MAXIMUM SOCIAL DISTANCING OCCUPANCY LOAD IN COURTROOM IS 29

MAXIMUM SOCIAL DISTANCING OCCUPANCY LOAD IN WAITING ROOM IS 10

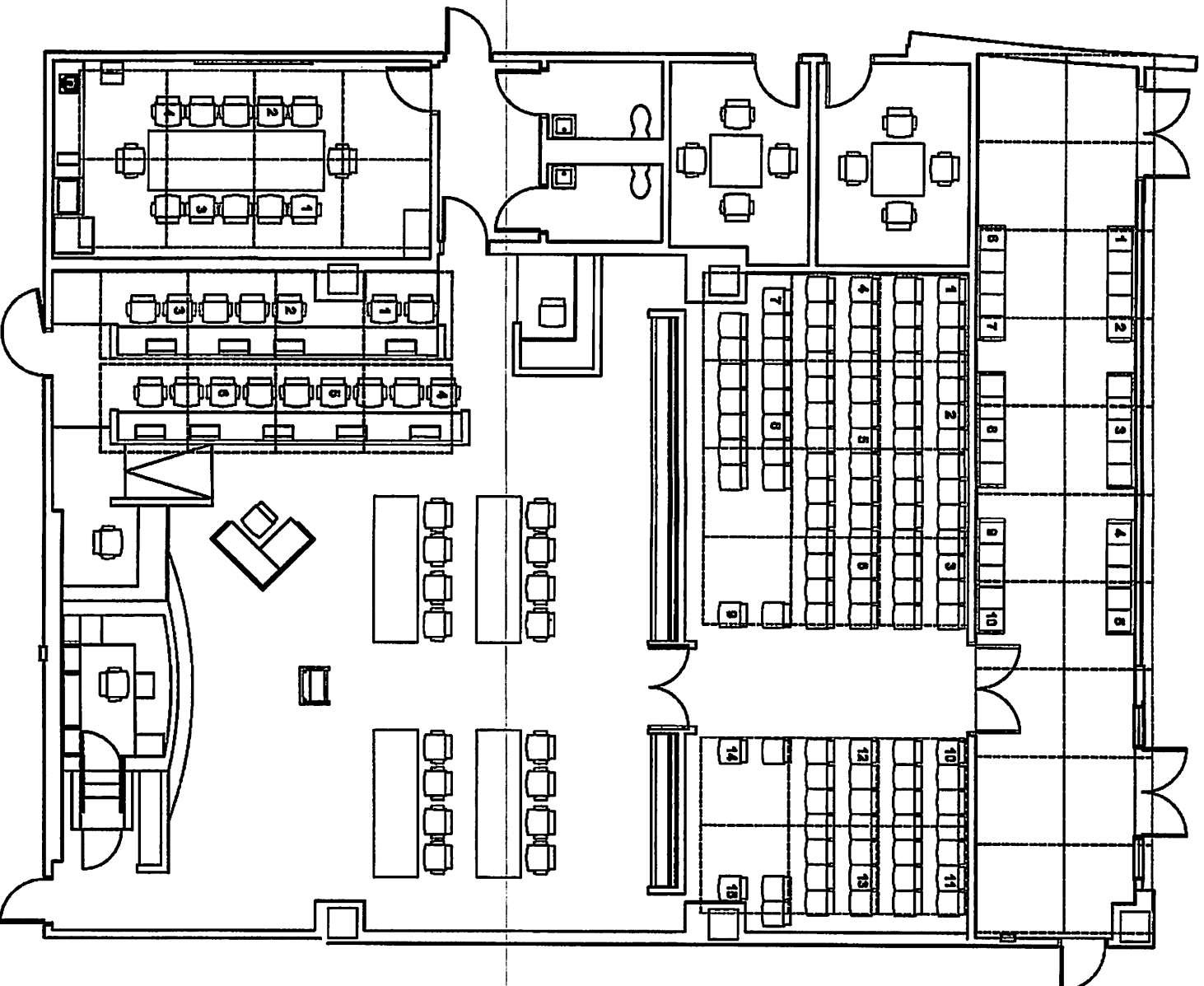

Charles Murray Courthouse and Waiting Room

Second Floor

# TOM VANDERGRIFF CIVIL COURTS BUILDING

MAXIMUM SOCIAL DISTANCING OCCUPANCY LOAD IS 23

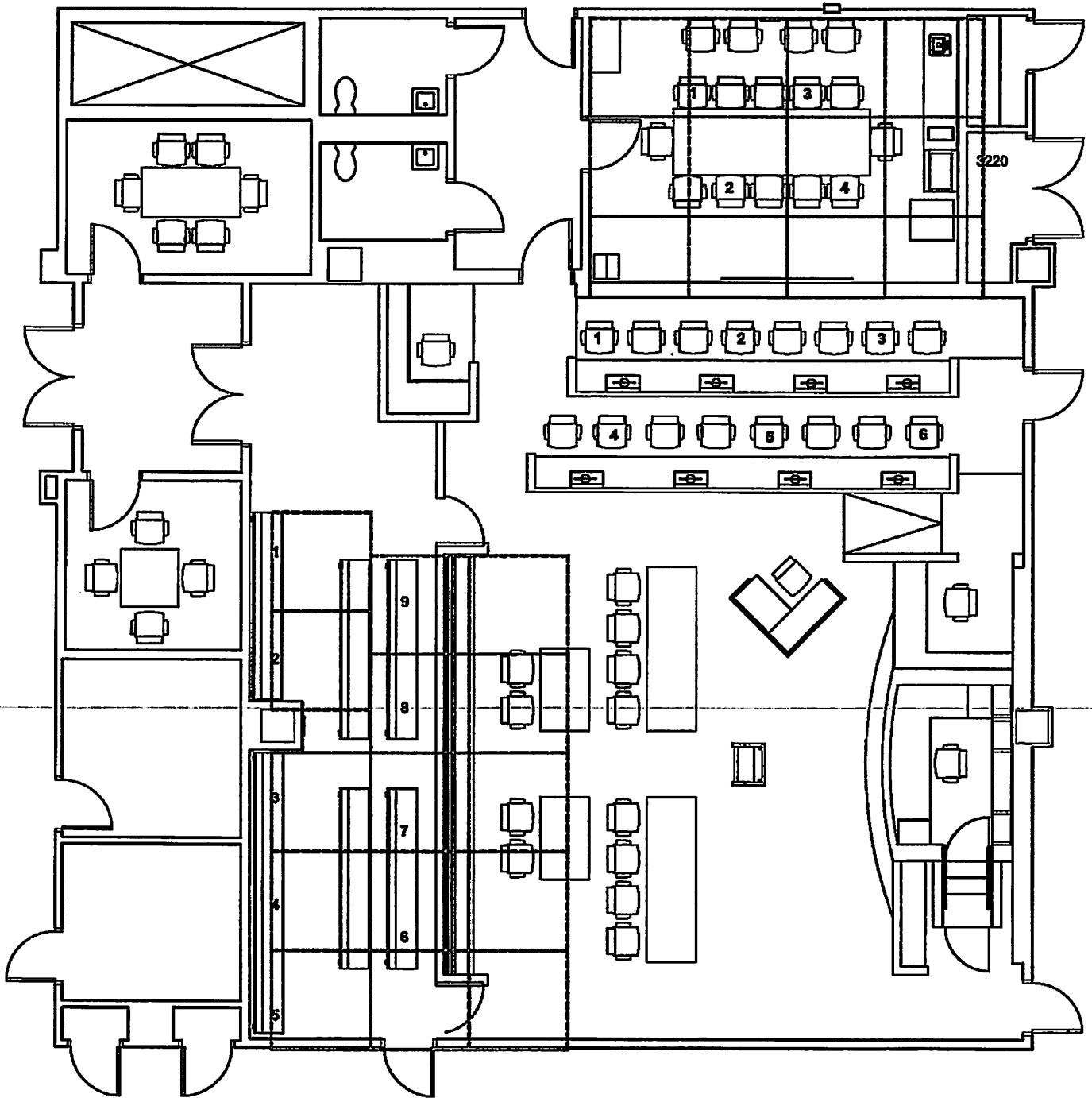

348th Dist. Ct.  
17th Dist. Ct.  
141st Dist. Ct.  
153rd Dist. Ct.

48th Dist. Ct.  
96th Dist. Ct.  
67th Dist. Ct.  
352nd Dist. Ct.

236th Dist. Ct.  
342nd Dist. Ct.

# TOM VANDERGRIFF CIVIL COURTS BUILDING

MAXIMUM SOCIAL DISTANCING OCCUPANCY LOAD IS 30

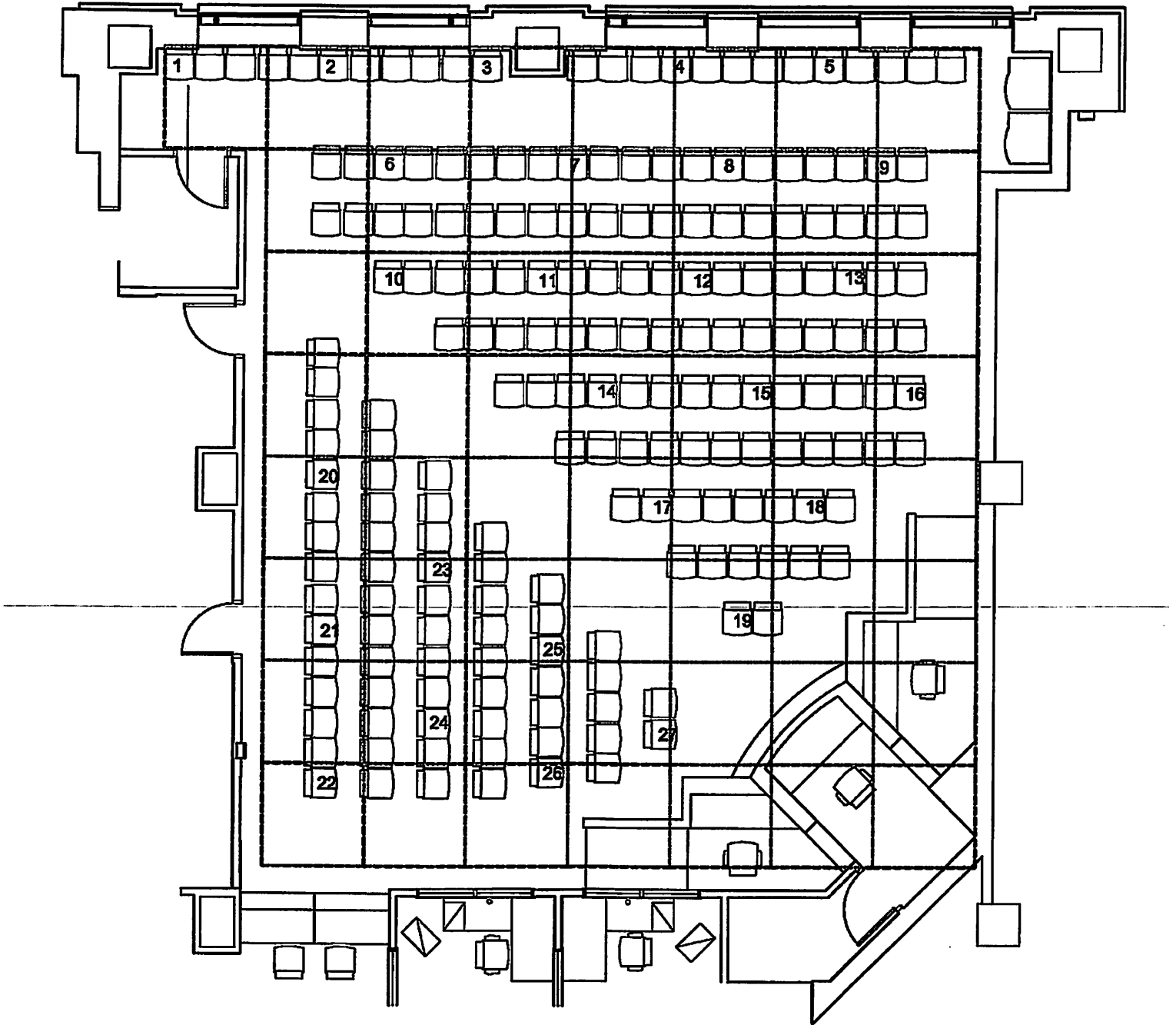

Jury Assembly Room

First Floor

# TOM VANDERGRIFF CIVIL COURTS BUILDING

MAXIMUM SOCIAL DISTANCING OCCUPANCY LOAD IS 6

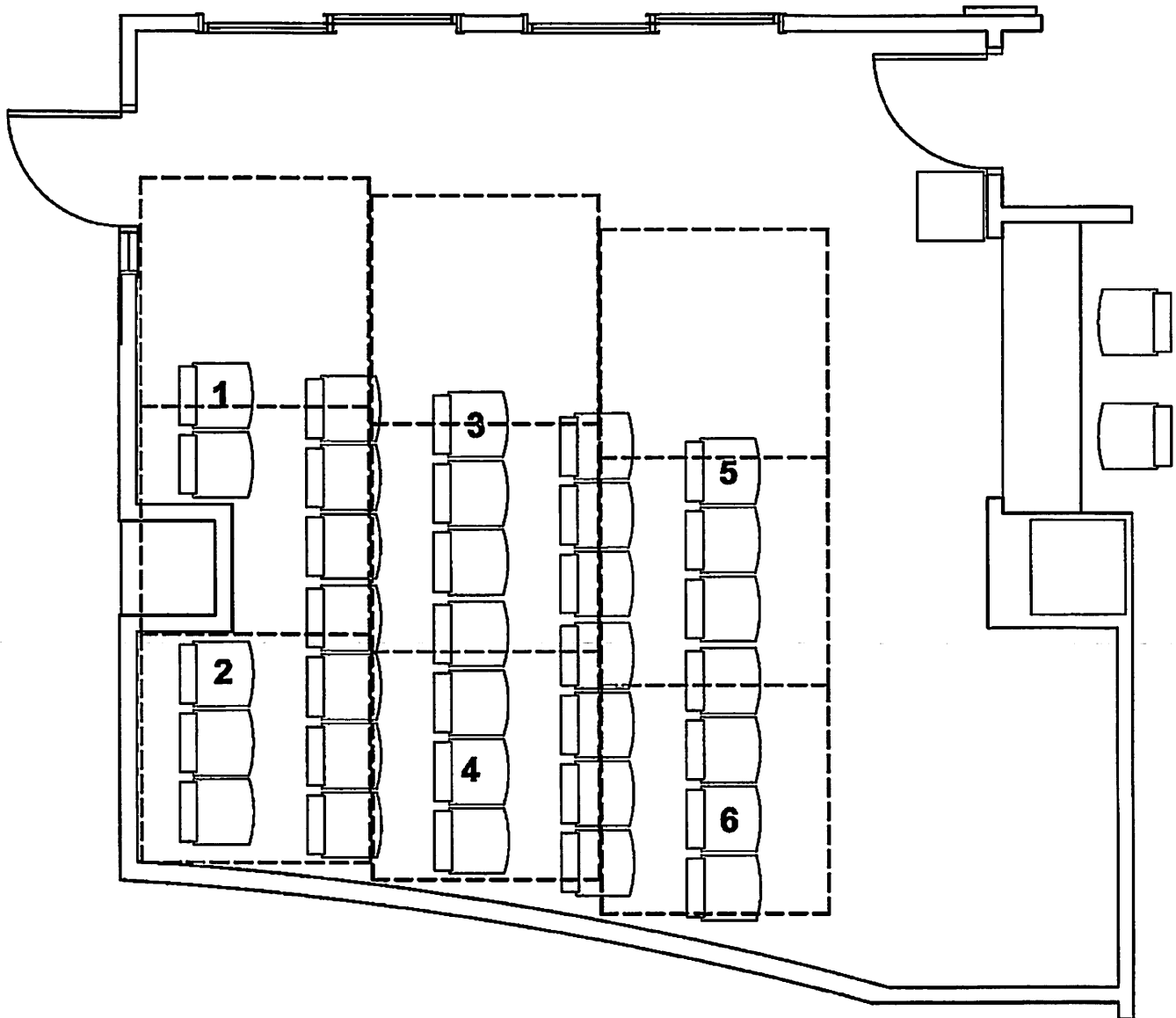

Jury Dismissal  
First Floor



# JUVENILE JUSTICE CENTER

MAXIMUM SOCIAL DISTANCING OCCUPANCY LOAD IS 14

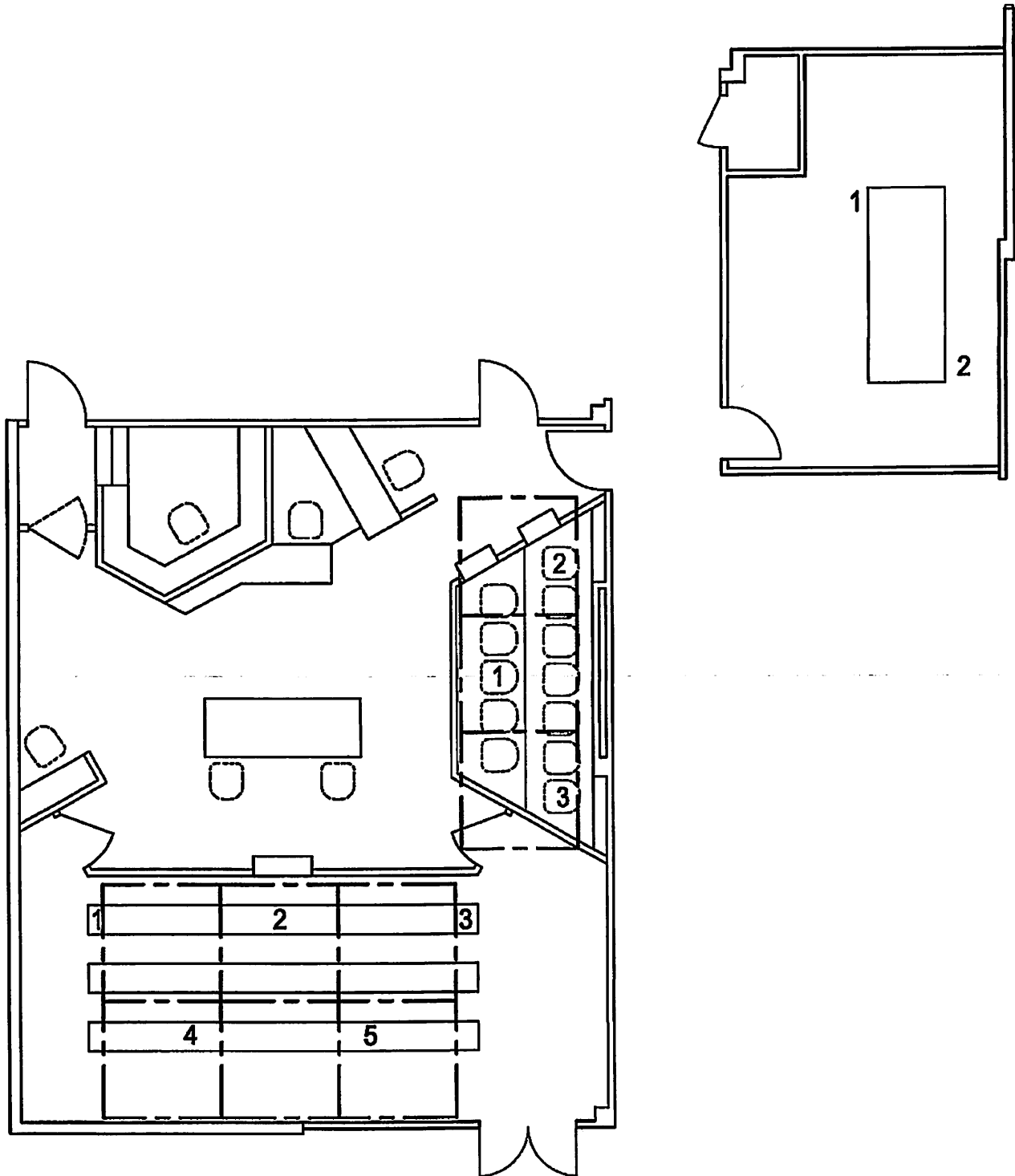

Courtroom A

# JUVENILE JUSTICE CENTER

MAXIMUM SOCIAL DISTANCING OCCUPANCY LOAD IS 14

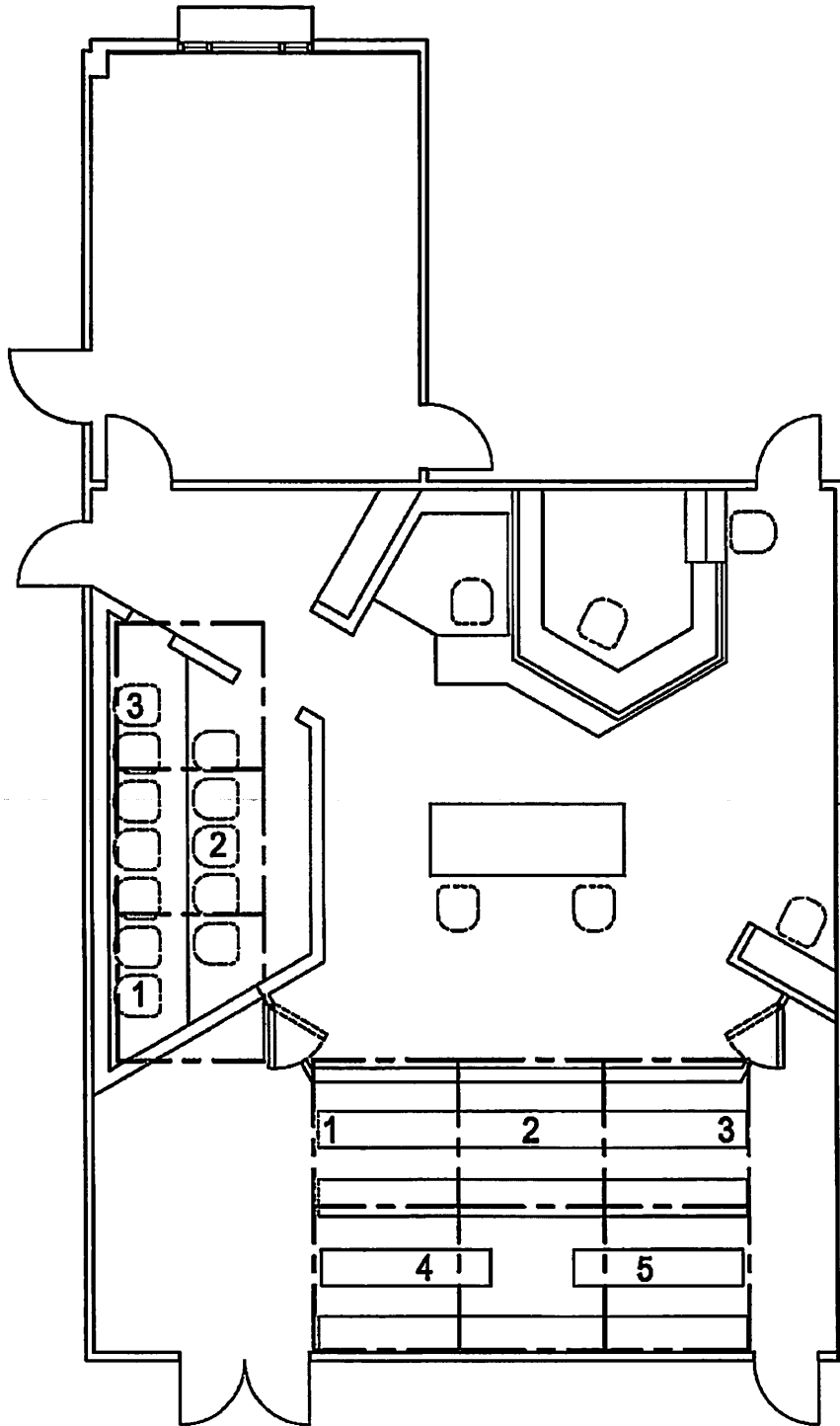

Courtroom B

# JUVENILE JUSTICE CENTER

MAXIMUM SOCIAL DISTANCING OCCUPANCY LOAD IS 15

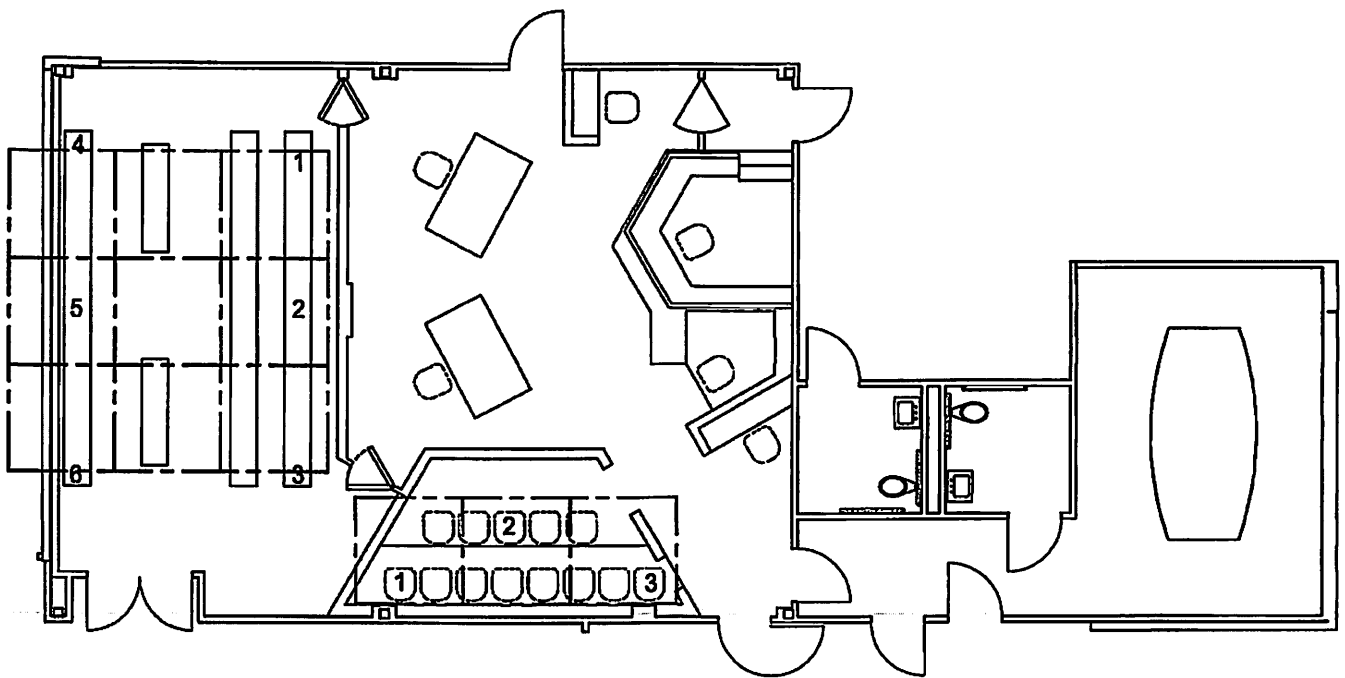

Courtroom C

# JUVENILE JUSTICE CENTER

MAXIMUM SOCIAL DISTANCING OCCUPANCY LOAD IS 8

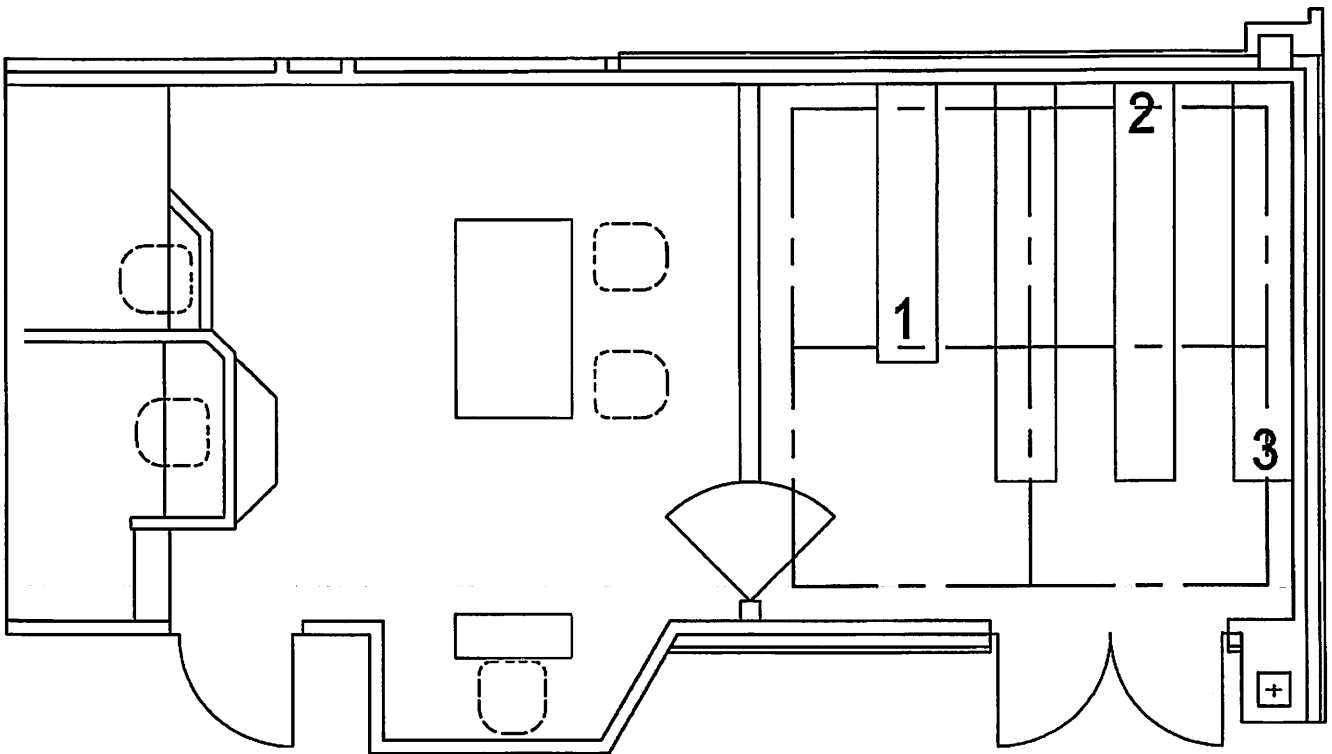

Courtroom D

# 1895 COURTHOUSE

MAXIMUM SOCIAL DISTANCING OCCUPANCY LOAD IS 15

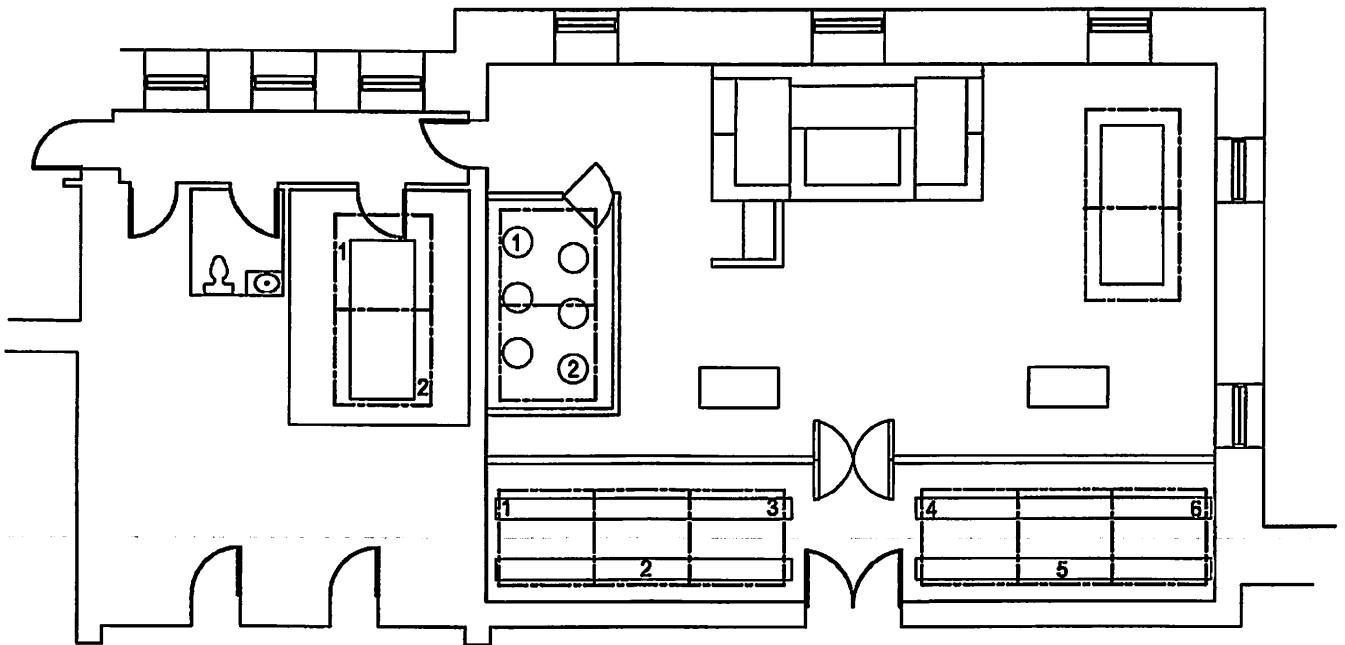

Probate Court #1  
Basement Level

# 1895 COURTHOUSE

MAXIMUM SOCIAL DISTANCING OCCUPANCY LOAD IS 15

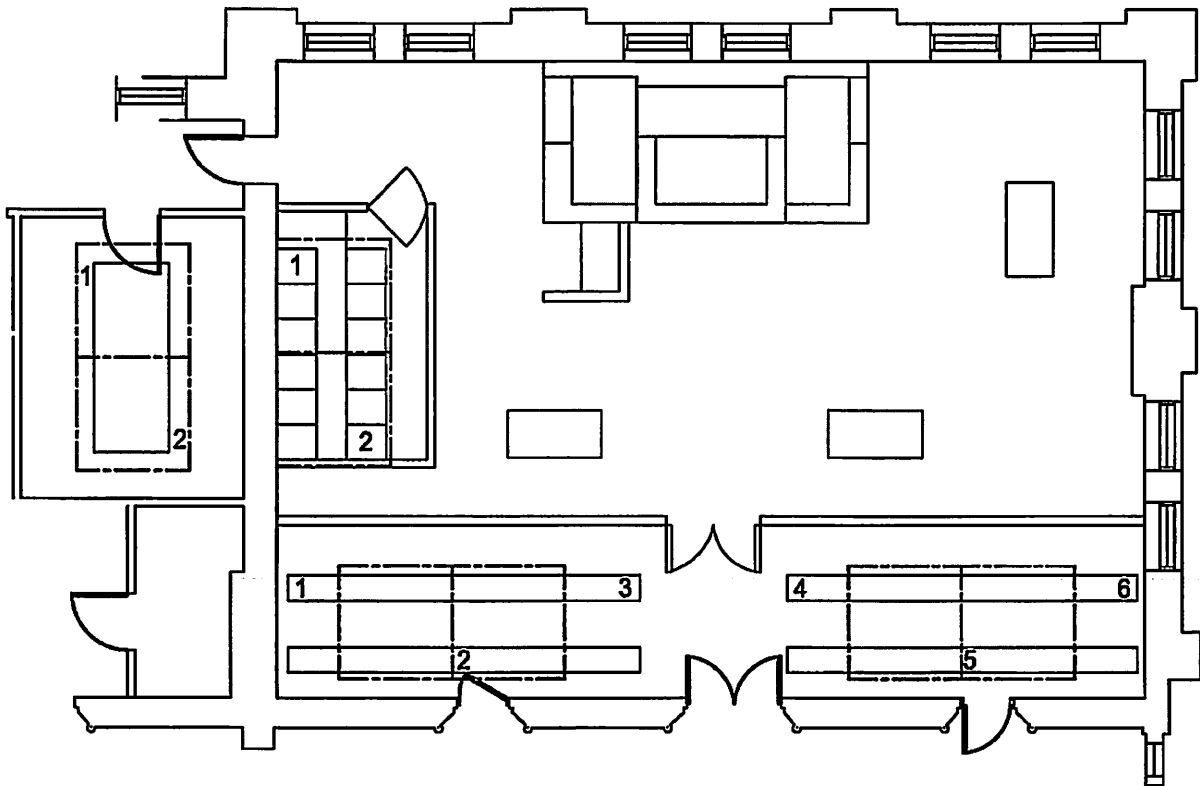

Probate Court #2  
First Floor

# 1895 COURTHOUSE

MAXIMUM SOCIAL DISTANCING OCCUPANCY LOAD IS 15

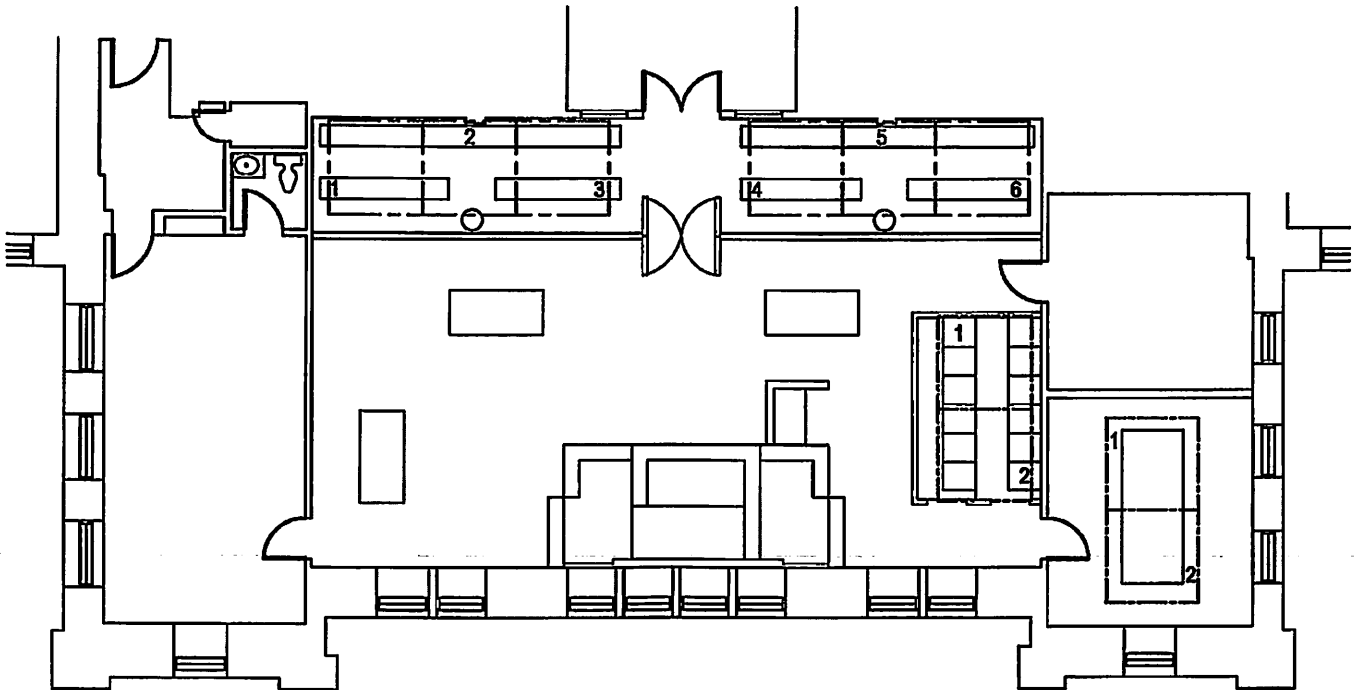

County Court at Law #3  
Second Floor

# 1895 COURTHOUSE

MAXIMUM SOCIAL DISTANCING OCCUPANCY LOAD IS 15

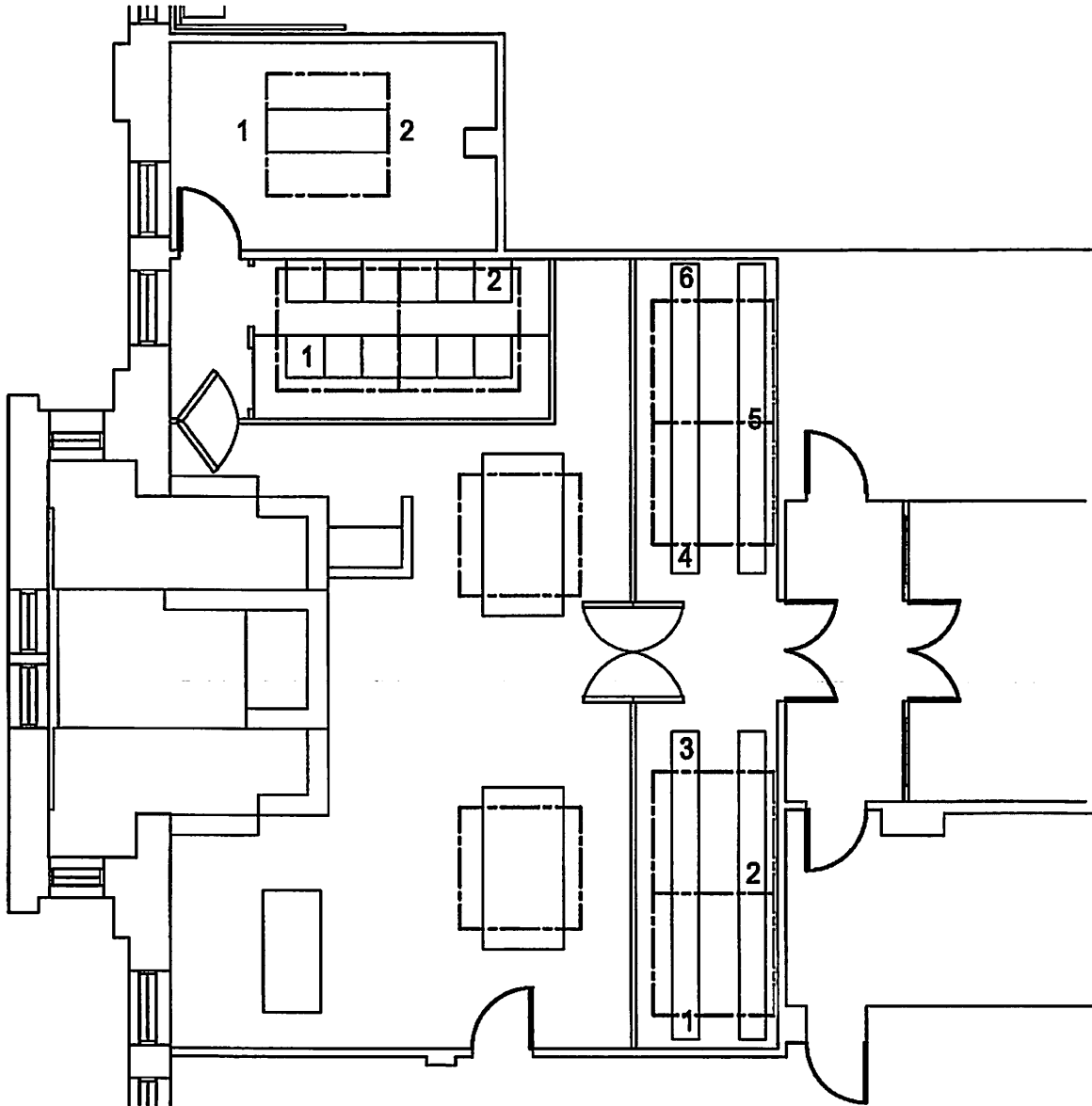

Probate Court #2  
Second Floor



# 1895 COURTHOUSE

MAXIMUM SOCIAL DISTANCING OCCUPANCY LOAD IS 15

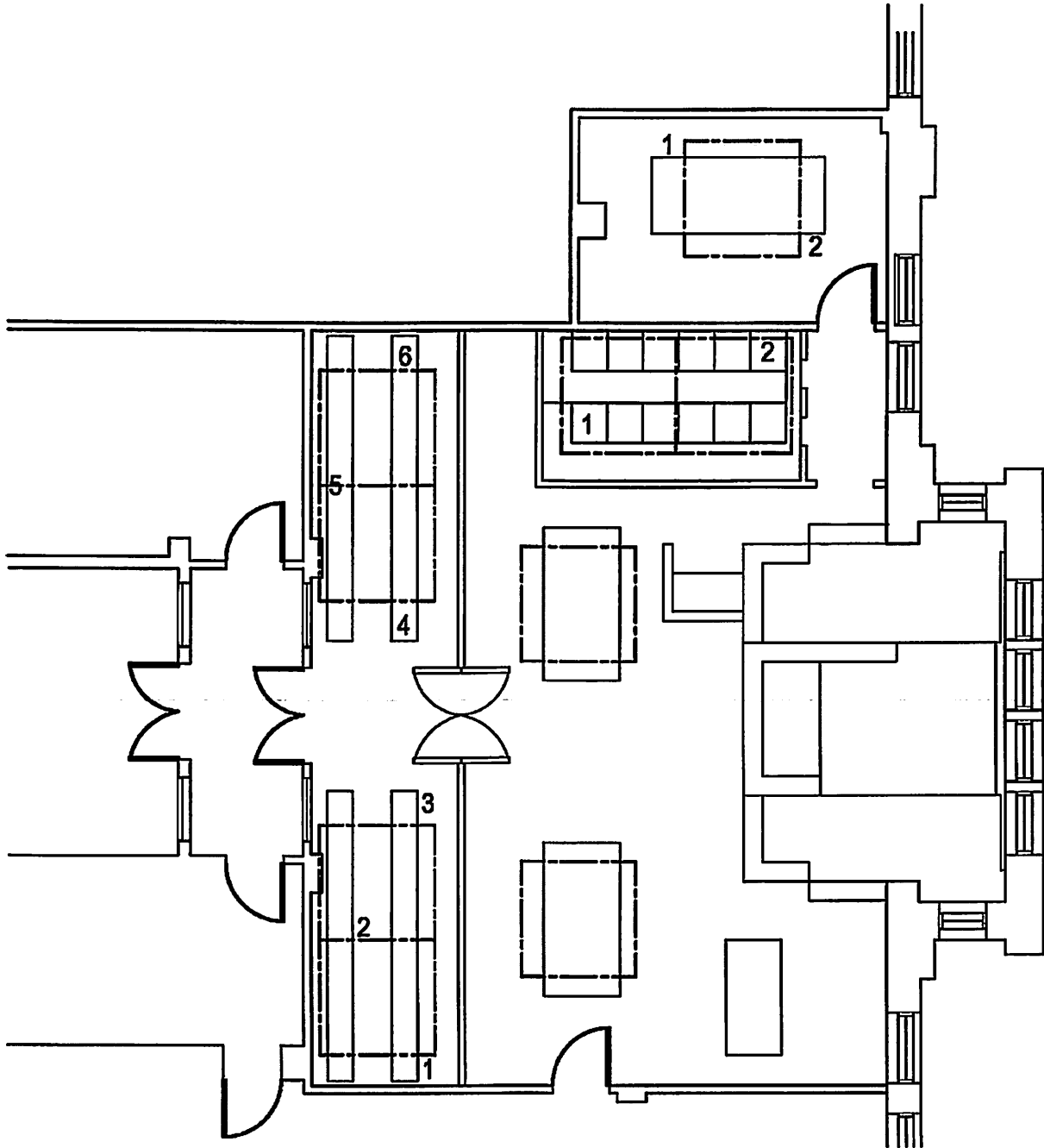

Probate Court #1  
Second Floor

# 1895 COURTHOUSE

MAXIMUM SOCIAL DISTANCING OCCUPANCY LOAD IS 15

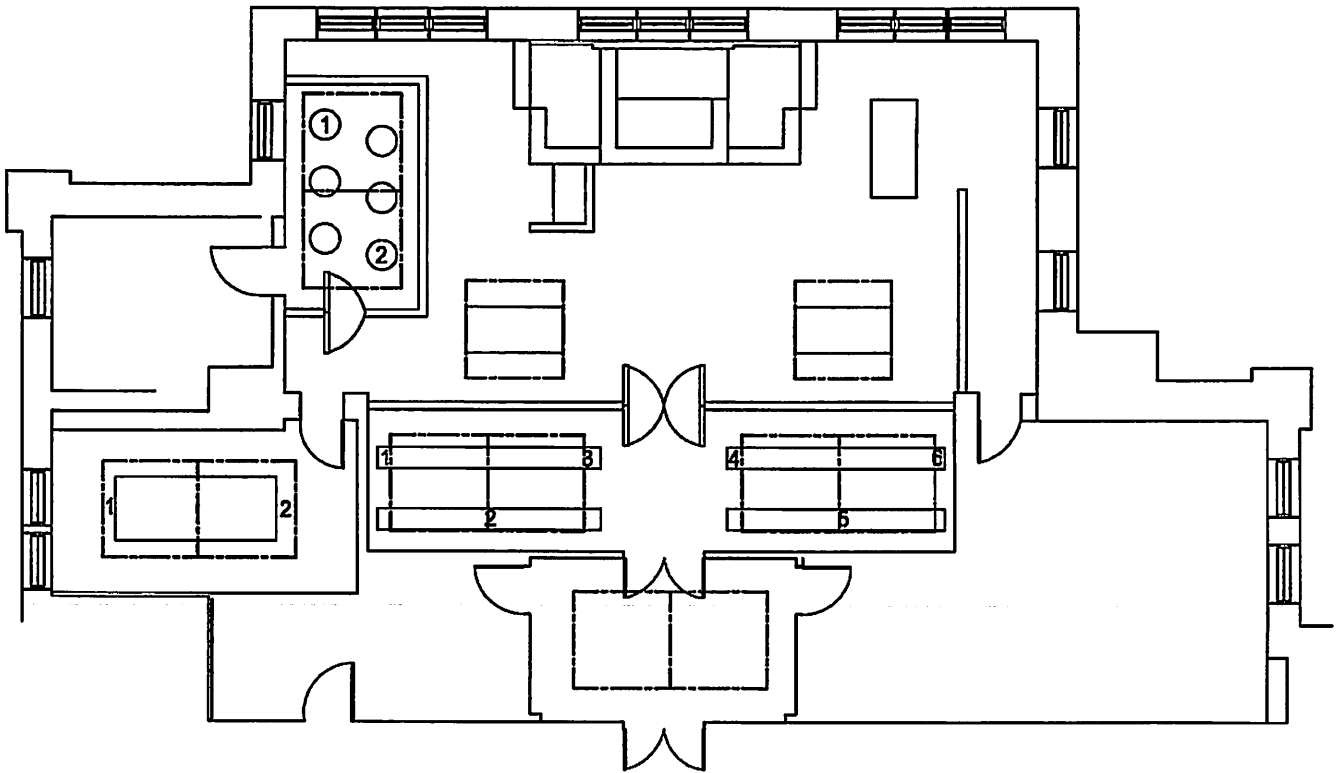

County Court at Law #2  
Second Floor

# 1895 COURTHOUSE

MAXIMUM SOCIAL DISTANCING OCCUPANCY LOAD IS 15

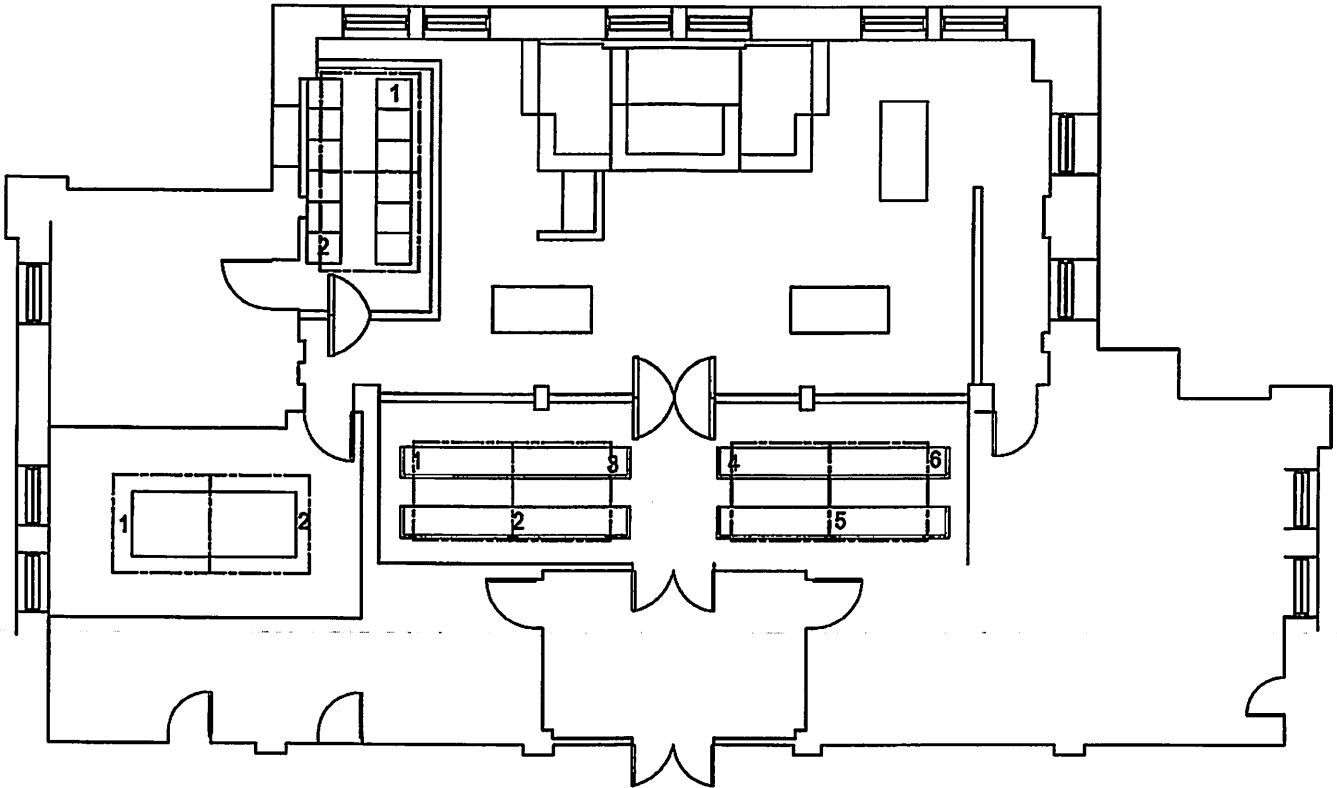

Justice of the Peace  
Fourth Floor

# 1895 COURTHOUSE

MAXIMUM SOCIAL DISTANCING OCCUPANCY LOAD IS 23

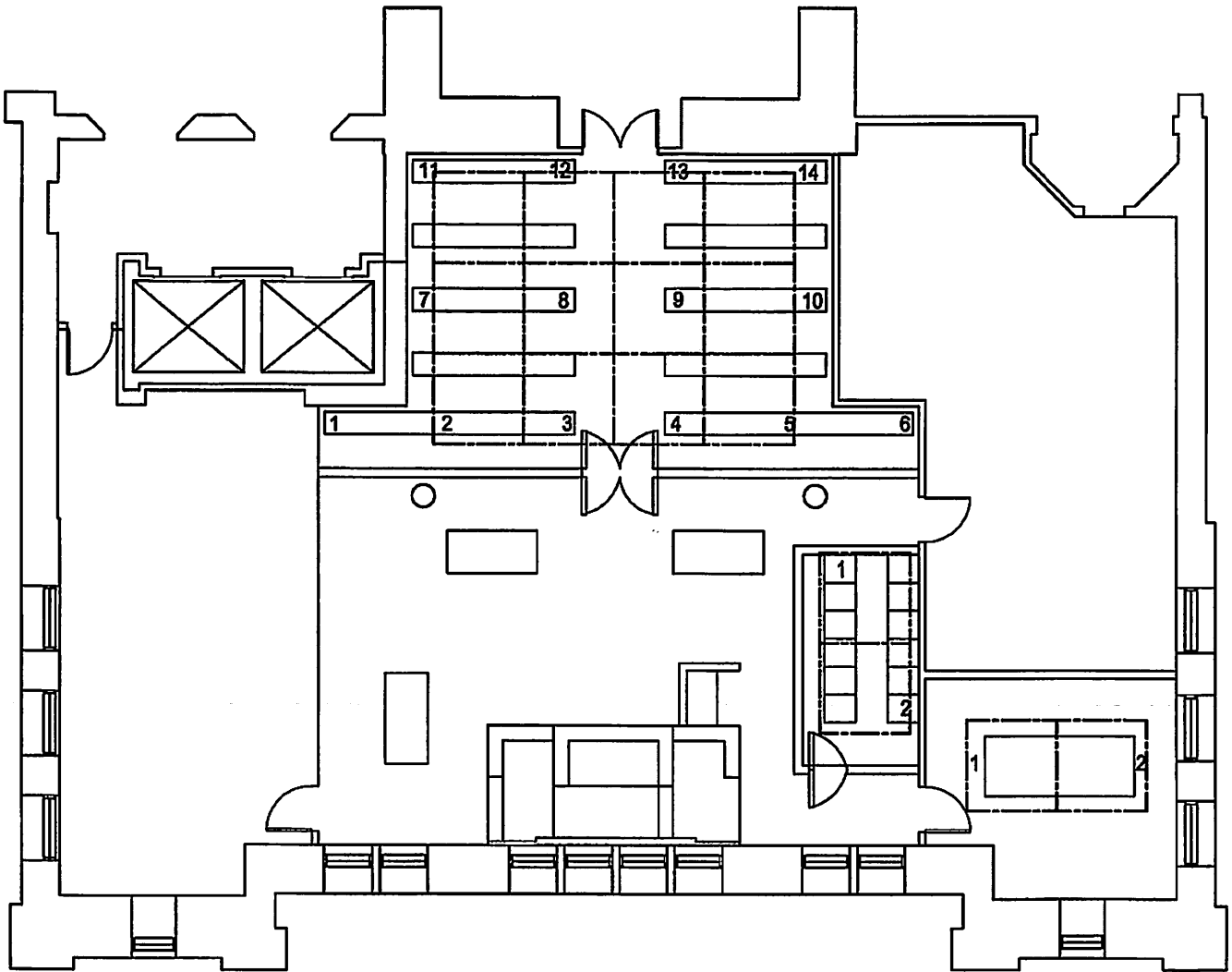

County Court at Law #1  
Fourth Floor

# RESOURCE CONNECTION BUILDING 2300

MAXIMUM SOCIAL DISTANCING OCCUPANCY LOAD IN GYM IS 108

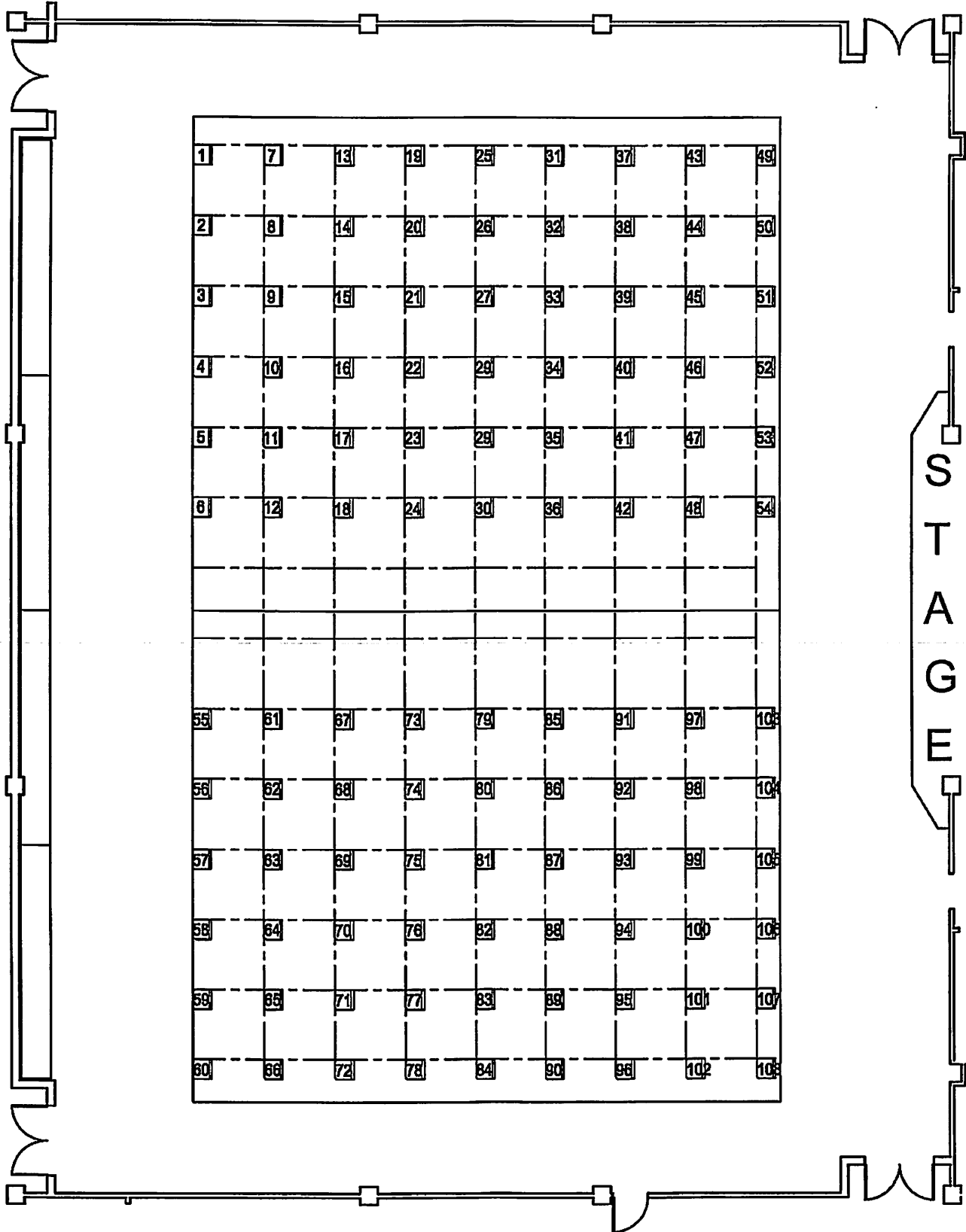

## **Jerome Hennigan**

---

**From:** Jerome Hennigan  
**Sent:** Tuesday, September 29, 2020 1:09 PM  
**To:** Jerome Hennigan  
**Subject:** FW: Jury Proceeding Addendum to COVID-19 Operating Plan

**From:** B. Glen Whitley  
**Sent:** Monday, September 28, 2020 4:49 PM  
**To:** Jerome Hennigan <JSHennigan@TarrantCounty.com>; Catherine A. Colquitt <CAColquitt@TarrantCounty.com>  
**Subject:** RE: Jury Proceeding Addendum to COVID-19 Operating Plan

Judge Hennigan,

I appreciate your hard work on this matter and your consultation with myself as well as with Dr. Colquitt, our Public Health Authority. The Jury Proceeding Addendum looks good to me.

Judge Whitley

## **Jerome Hennigan**

---

**From:** Jerome Hennigan  
**Sent:** Tuesday, September 29, 2020 1:06 PM  
**To:** Jerome Hennigan  
**Subject:** FW: Family Law Center: AutoCAD Drawings for Social Distancing In Courtrooms and Other Areas

**From:** Catherine A. Colquitt  
**Sent:** Tuesday, September 29, 2020 12:54 PM  
**To:** Jerome Hennigan <JSHennigan@TarrantCounty.com>  
**Subject:** RE: Family Law Center: AutoCAD Drawings for Social Distancing In Courtrooms and Other Areas

Hello Judge Hennigan,

I've reviewed your plan and updated AutoCAD drawings, have consulted with you, and believe that the measures you have in place are sufficient to ensure the protection of the participants in jury trials. The distance between persons in the courtroom should be a minimum of 6 feet, and masking as well as cough and hand hygiene are essential elements as well. I would suggest that, in addition to screening for fever, participants might be asked about a list of COVID-19 symptoms (fever, cough, shortness of breath, muscle/body aches, vomiting, diarrhea, new loss of taste or smell), close contact with a person or persons with COVID-19, and whether the participant is waiting on a COVID-19 test result. Some screening with these questions could even be done prior to the arrival in the court building, Resource Connection, etc, with an downloaded questionnaire. I understand that I will need to discuss each planned jury trial prior to its start. I am to meet T Pelle at Tim Curry at 1500 to walk through a courtroom. I greatly appreciate all the work you and your team have done to safely resume court proceedings and jury trials and look forward to helping.

All best, Kate Colquitt



**JUDGE JEROME HENNIGAN**

324TH JUDICIAL DISTRICT OF TEXAS  
4TH FLOOR FAMILY LAW CENTER  
200 E. WEATHERFORD  
FORT WORTH, TEXAS 76196  
(817) 884-1432

BETH A. POULOS  
ASSOCIATE JUDGE  
817-884-1991

JENNIFER HUNTER, OFFICIAL REPORTER  
817-884-1430  
PRISCILLA POYNOR, COORDINATOR  
817-884-1571

November 23, 2020

Judge David L. Evans  
Eighth Administrative Judicial Region  
Office of Presiding Judge  
Tom Vandergriff Civil Courts Building  
100 N. Calhoun Street  
Fort Worth, Texas 76196-1148

Re: First Supplement to the Jury Proceeding Addendum to COVID-19  
Operating Plan for the Tarrant County Judiciary Effective On and after  
November 23, 2020

Dear Judge Evans:

Please accept the following as a first supplement to the Jury Proceeding  
Addendum to the COVID-19 Operating Plan for the Tarrant County Judiciary:

1. Beginning on November 23, 2020, all jury trial plans must be submitted no later than forty-five (45) days in advance of the proposed trial date.
2. All jury trial plans must include a provision for a contact tracing list to be kept by the judge of the trial court and to include the printed names, telephone numbers, email addresses, and signatures of all persons entering the courtroom during the course of the trial.



3. Current CAD drawings for all courts located in the Tim Curry Justice Center, the Vandergriff Civil Courts Building, the Family Law Center, the 1895 Courthouse, the Scott D. Moore Juvenile Justice Center, and the Resource Connection Building are attached.

I would appreciate your prompt consideration of this supplement. Please contact me if you have any questions or concerns.

Sincerely,

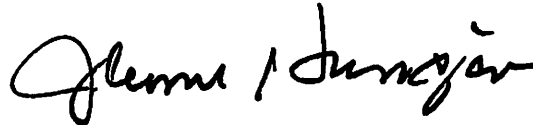
A handwritten signature in black ink, appearing to read "Jerome S. Hennigan". The signature is written in a cursive, flowing style.

JEROME S. HENNIGAN

# TIM CURRY CRIMINAL JUSTICE CENTER

## Courtroom Group A

MAXIMUM SOCIAL DISTANCING OCCUPANCY LOAD IS 27

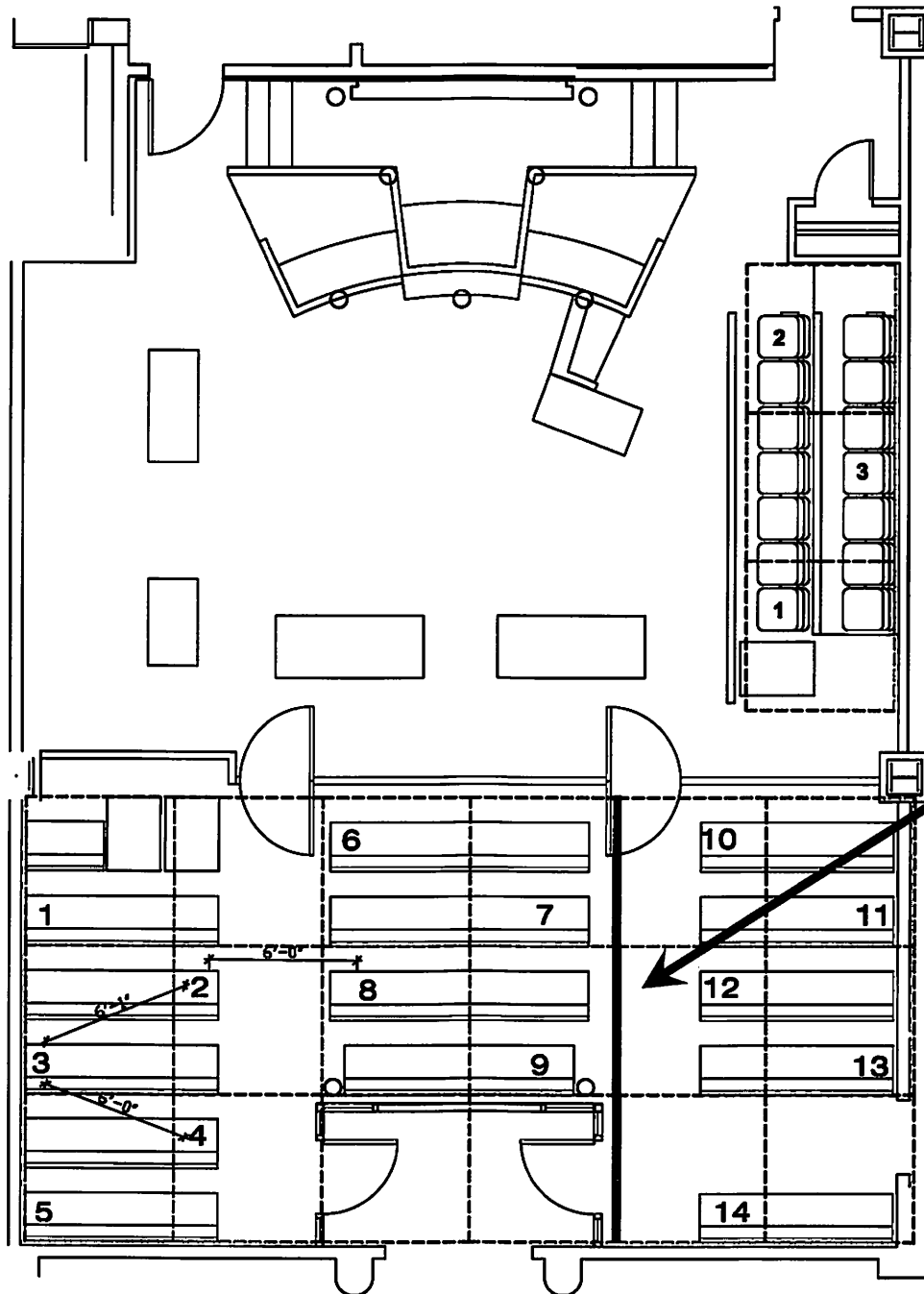

Felony IA  
Plexiglass  
Barrier Wall  
installed  
7/21/2020.

**5th Floor**  
297th  
CDC #1  
CCC #1  
CCC #4

**6th Floor**  
372nd  
396th  
432nd  
CCC #2  
CCC #5  
Voir Dire

**7th Floor**  
Aux B  
Aux C  
CCC #3  
CCC #8  
CCC #10  
Felony 1st Appearance

**8th Floor**  
213th  
371st  
Aux A  
CCC #6  
CCC #7  
TechShare

**CURRENT**

# TIM CURRY CRIMINAL JUSTICE CENTER

## Courtroom Group B

MAXIMUM SOCIAL DISTANCING OCCUPANCY LOAD IS 28

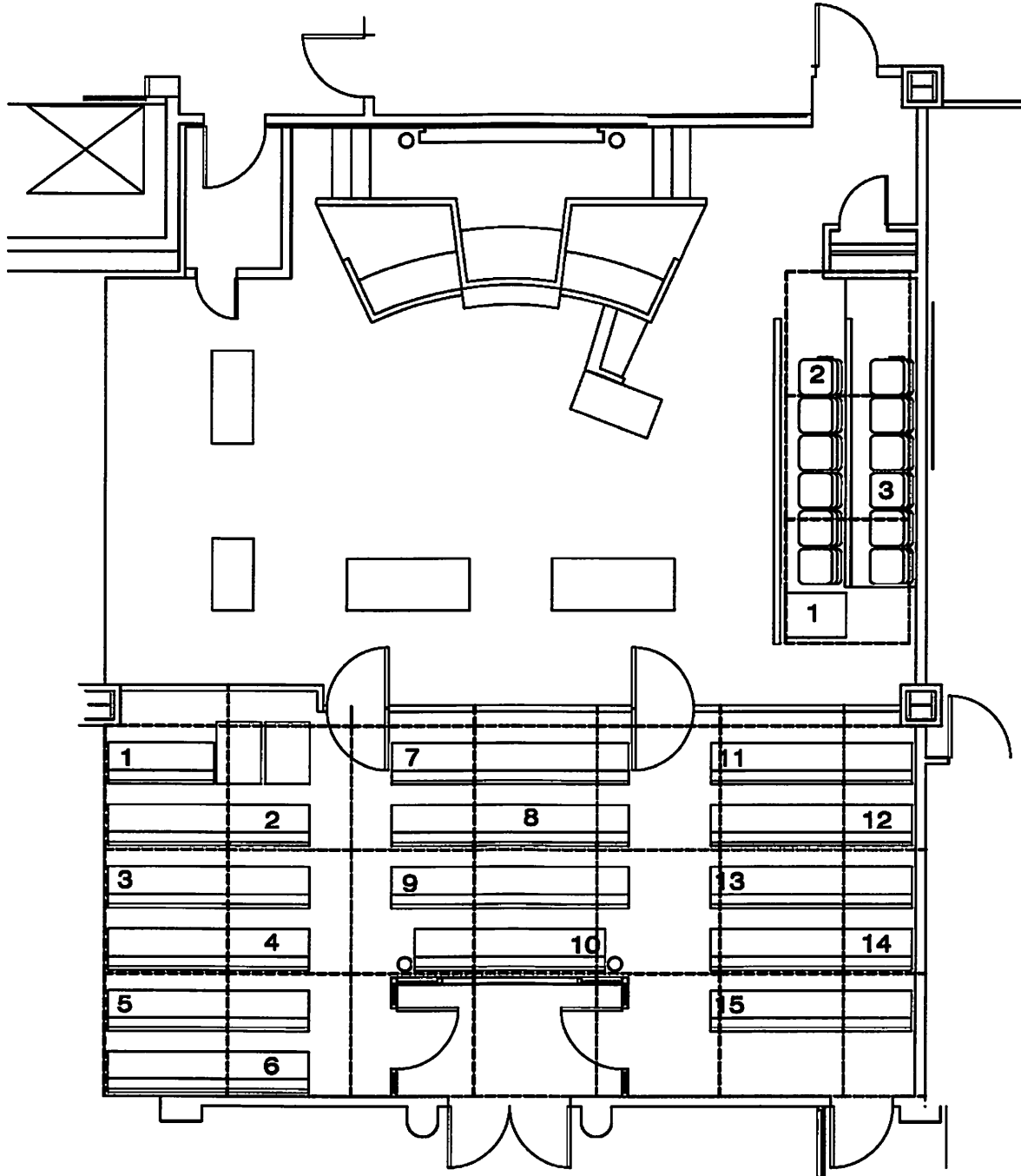

**6th Floor**

CDC #2

**7th Floor**

CDC #3

**8th Floor**

CDC #4

CURRENT

# TIM CURRY CRIMINAL JUSTICE CENTER

## Courtroom Group C

MAXIMUM SOCIAL DISTANCING OCCUPANCY LOAD IS 22

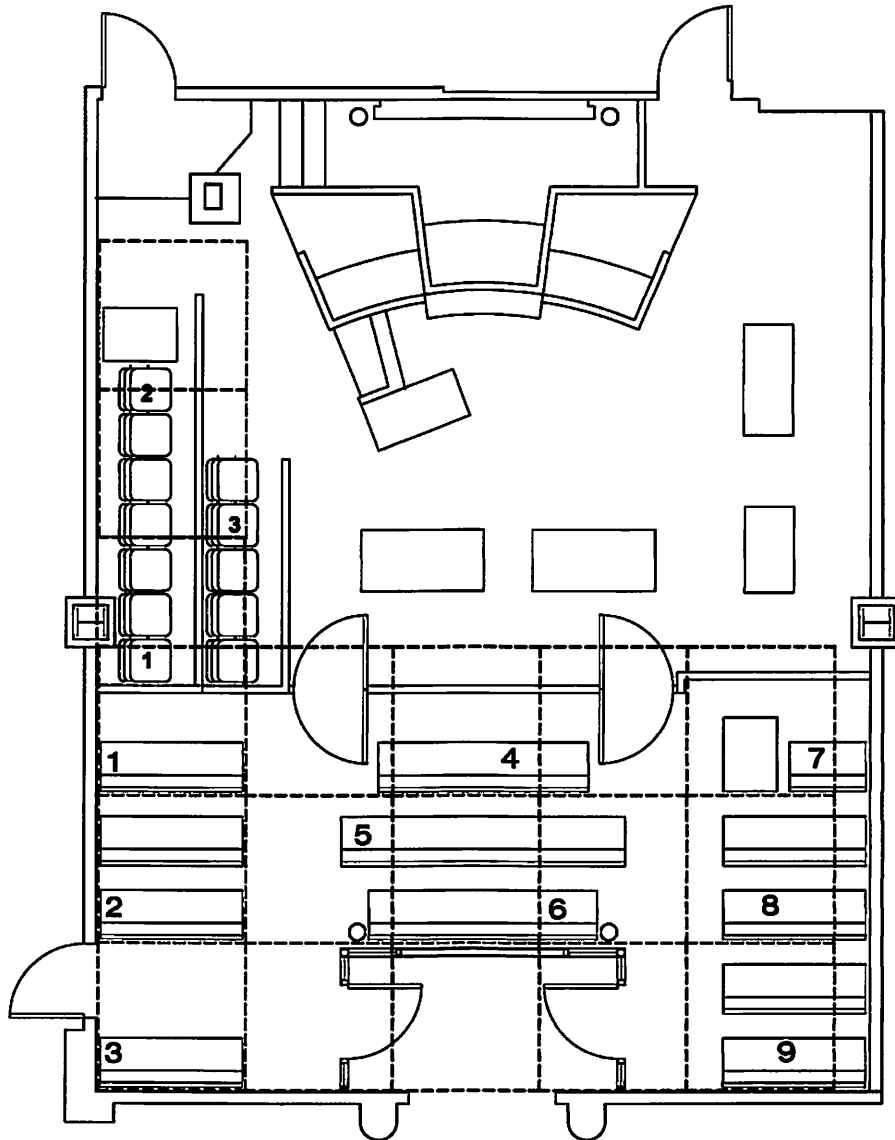

**6th Floor**

Aux E

**7th Floor**

Aux D

**8th Floor**

CCC #9

CURRENT

# TIM CURRY CRIMINAL JUSTICE CENTER

## North/South Jury Rooms

MAXIMUM SOCIAL DISTANCING OCCUPANCY LOAD IS 3

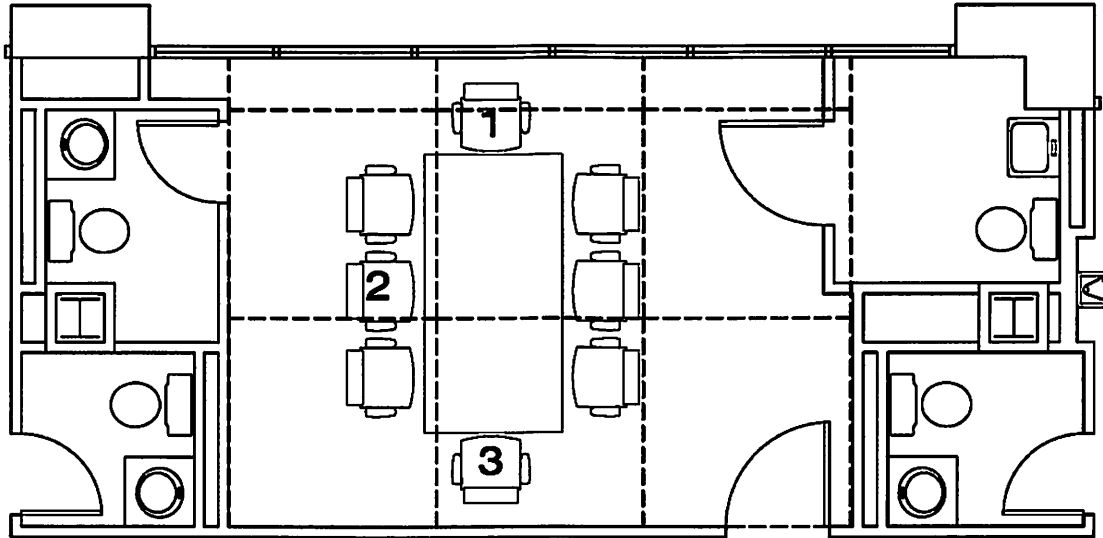

**5th Floor**  
CCC #1  
CCC #4

**6th Floor**  
Aux E  
372nd Dist. Ct.  
432nd Dist. Ct.  
CCC #2

**7th Floor**  
Aux B  
Aux C  
Aux D  
CCC #8

**8th Floor**  
213th Dist. Ct.  
CCC #7  
CCC #9  
TechShare

**CURRENT**

# TIM CURRY CRIMINAL JUSTICE CENTER

MAXIMUM SOCIAL DISTANCING OCCUPANCY LOAD IS 89

REVISION #1 OCTOBER 12, 2020

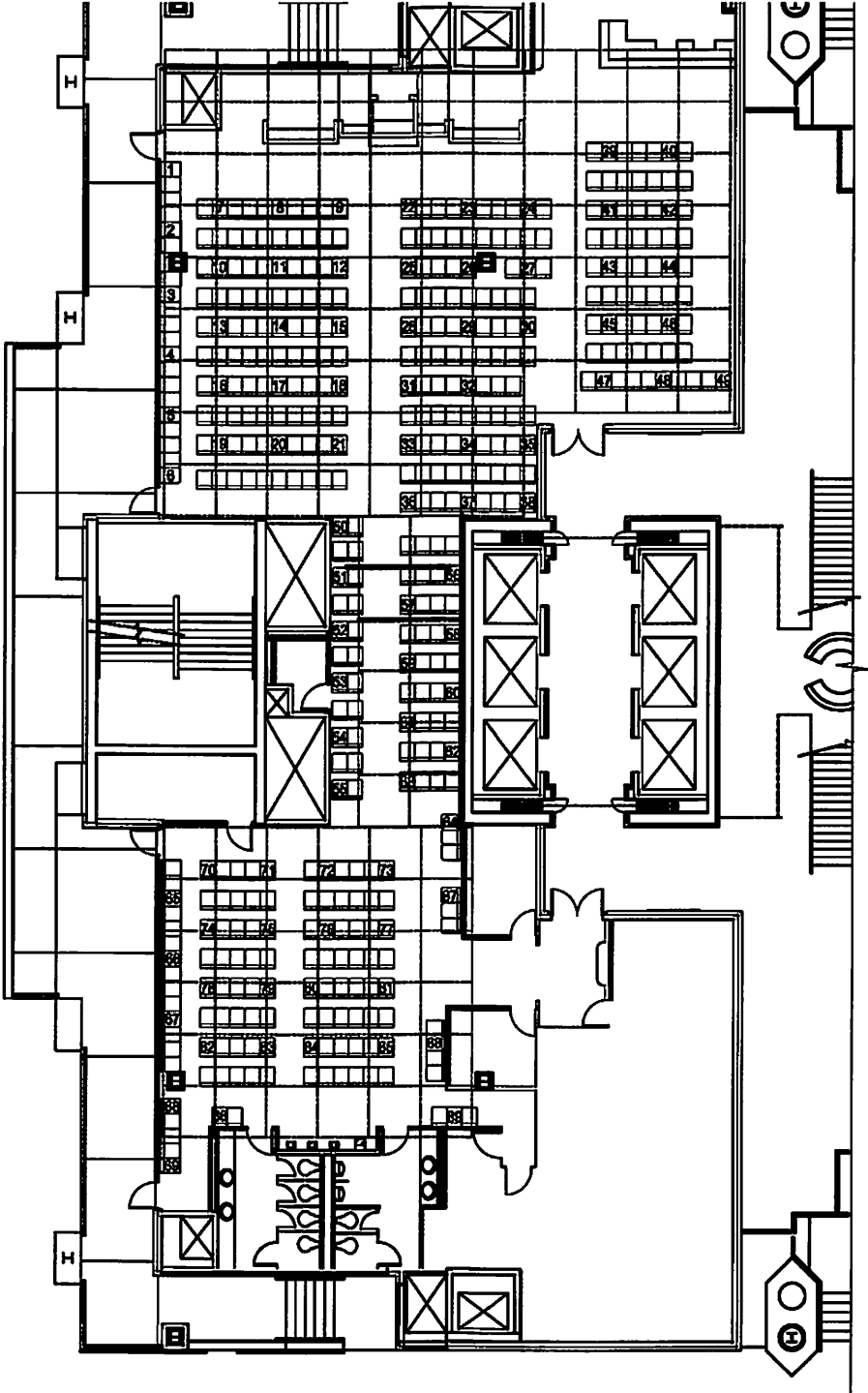

Central Jury Room  
Plaza Level  
Line of Sight to Bench is 64

CURRENT

# TIM CURRY CRIMINAL JUSTICE CENTER

## East/West Jury Rooms

MAXIMUM SOCIAL DISTANCING OCCUPANCY LOAD IS 3

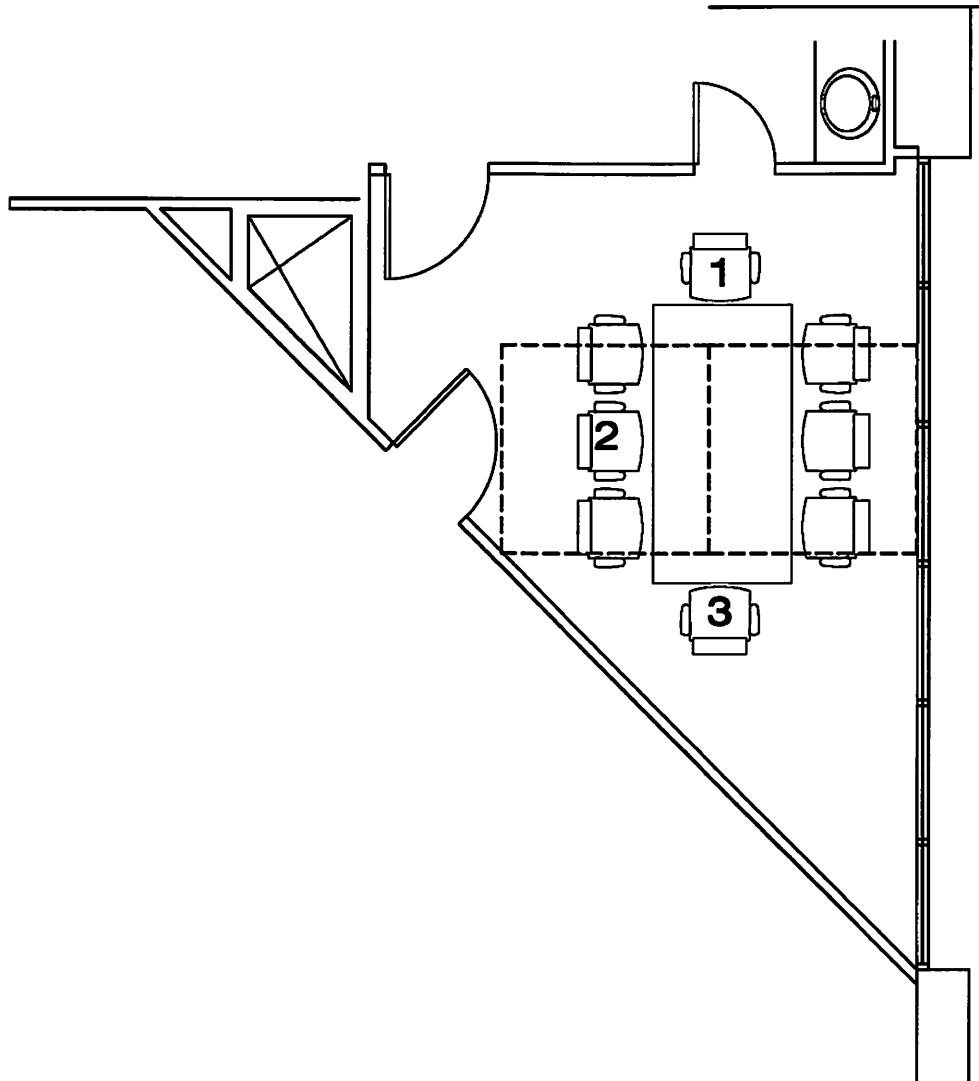

**5th Floor**  
297th  
CDC #1

**6th Floor**  
396th  
CCC #5  
CDC #2  
Voir Dire

**7th Floor**  
CCC #3  
CCC #10  
CDC #3  
Felony 1st Appearance

**8th Floor**  
371st  
Aux A  
CCC #6  
CDC #4

**CURRENT**

# TIM CURRY CRIMINAL JUSTICE CENTER

MAXIMUM SOCIAL DISTANCING OCCUPANCY LOAD IS 14

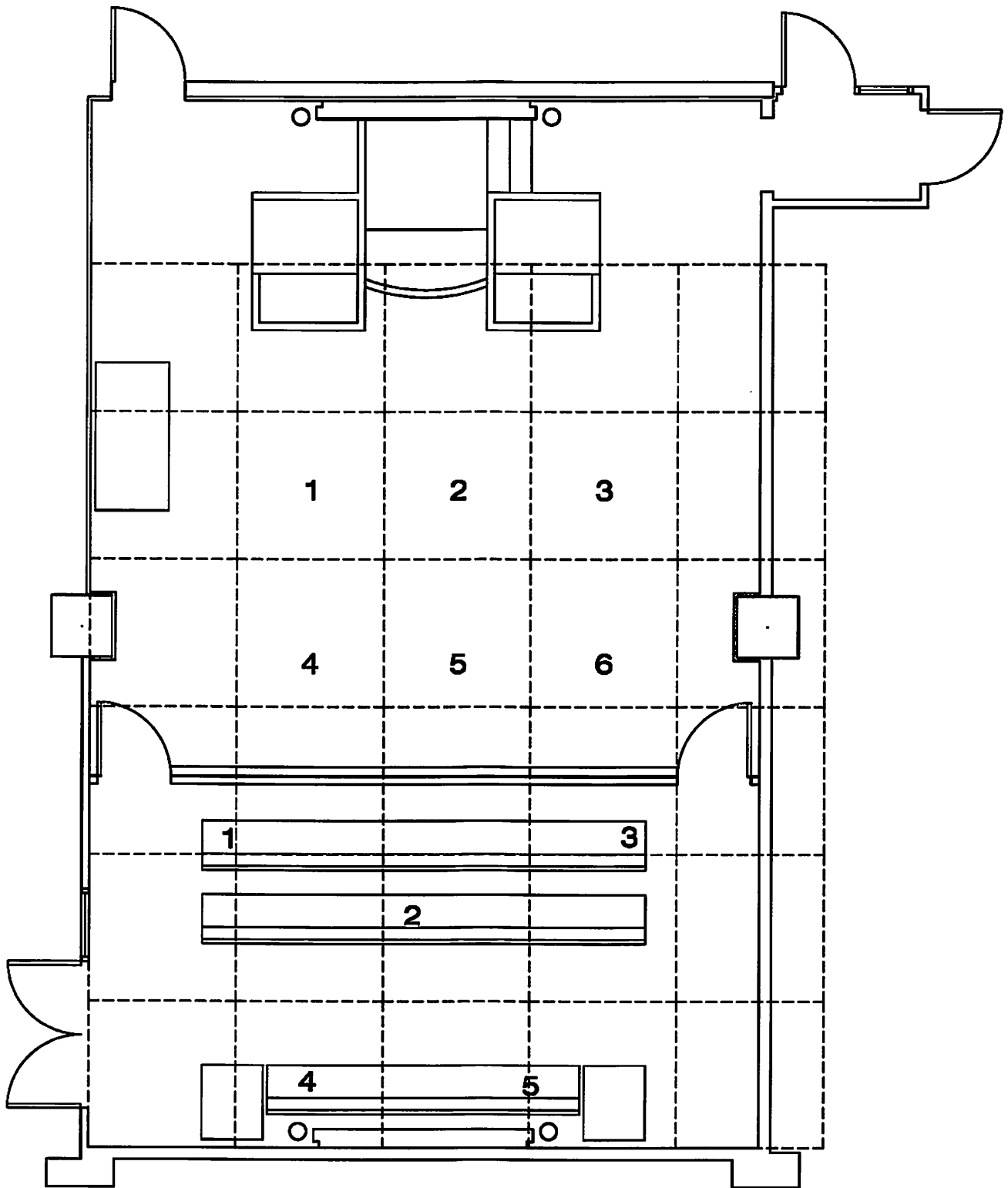

Magistrate  
Basement Level

CURRENT



# TOM VANDERGRIFF CIVIL COURTS BUILDING

MAXIMUM SOCIAL DISTANCING OCCUPANCY LOAD IS 45

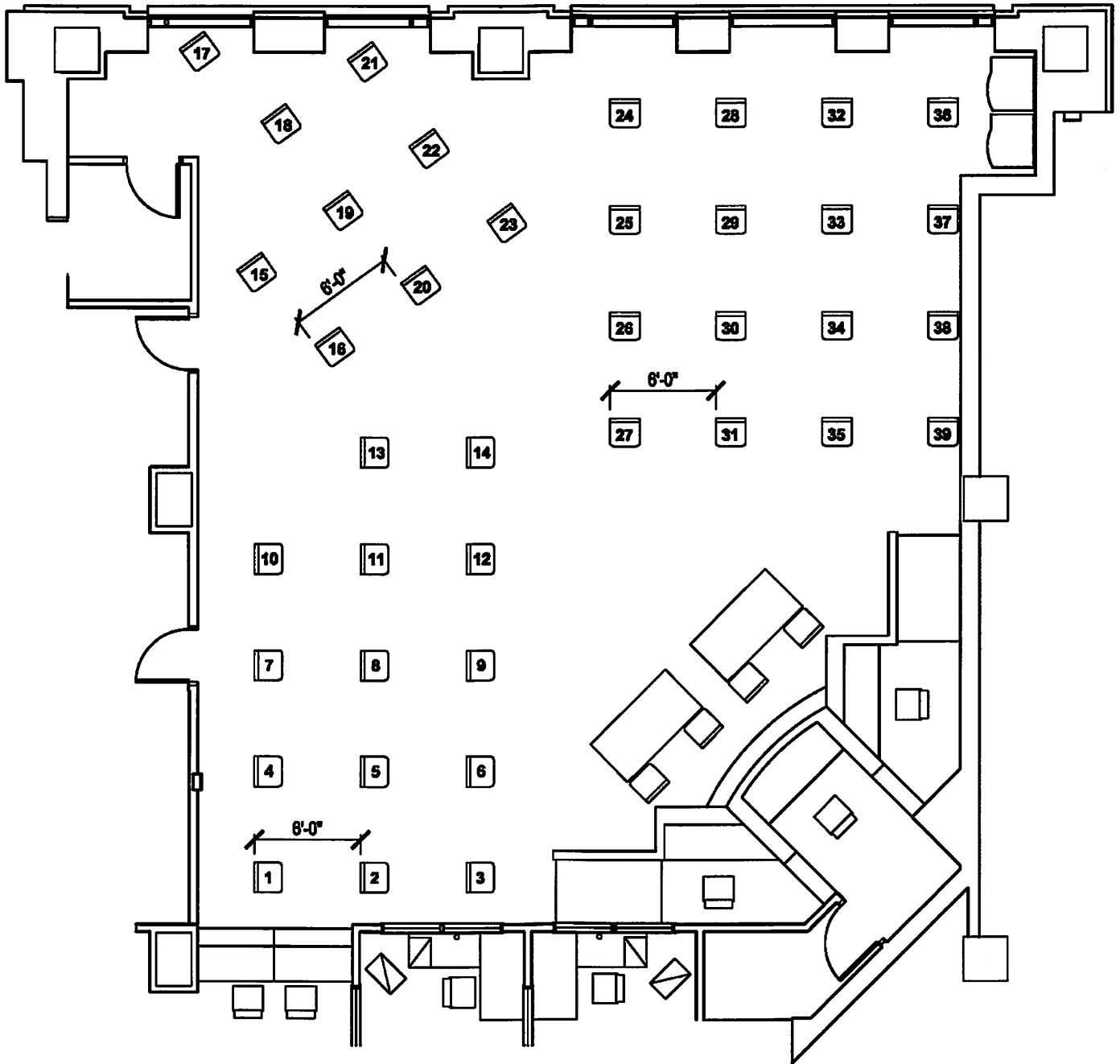

Jury Assembly Room - Alternate #1  
First Floor

CURRENT

# TOM VANDERGRIFF CIVIL COURTS BUILDING

MAXIMUM SOCIAL DISTANCING OCCUPANCY LOAD IS 6

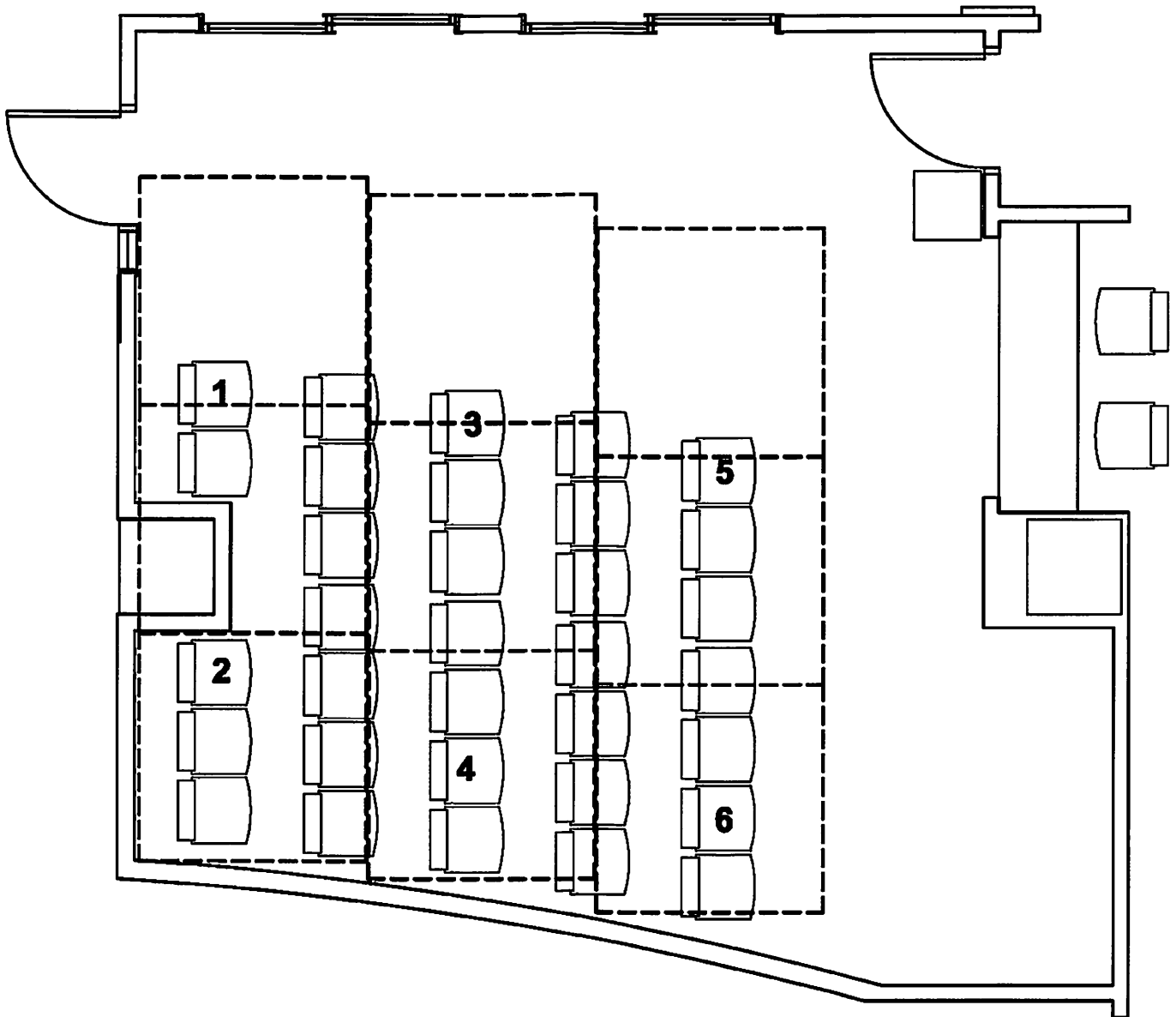

Jury Dismissal  
First Floor

CURRENT

# TOM VANDERGRIFF CIVIL COURTS BUILDING

MAXIMUM SOCIAL DISTANCING OCCUPANCY LOAD IN COURTROOM IS 50

MAXIMUM SOCIAL DISTANCING OCCUPANCY LOAD IN WAITING ROOM IS 10

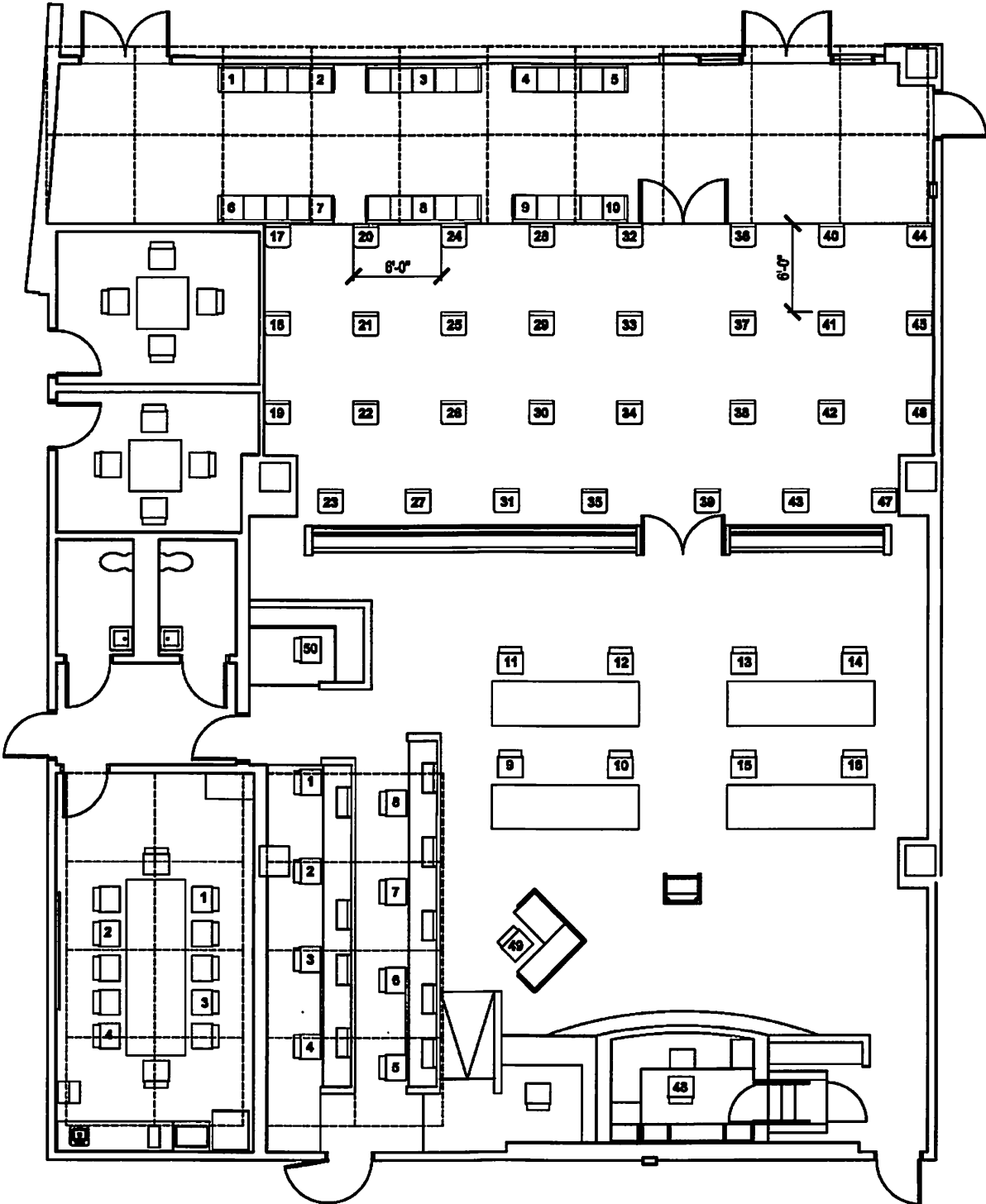

Charles Murray Courtroom and Waiting Room

Alternate #1

Second Floor

CURRENT

# TOM VANDERGRIFF CIVIL COURTS BUILDING

MAXIMUM SOCIAL DISTANCING OCCUPANCY LOAD IS 30

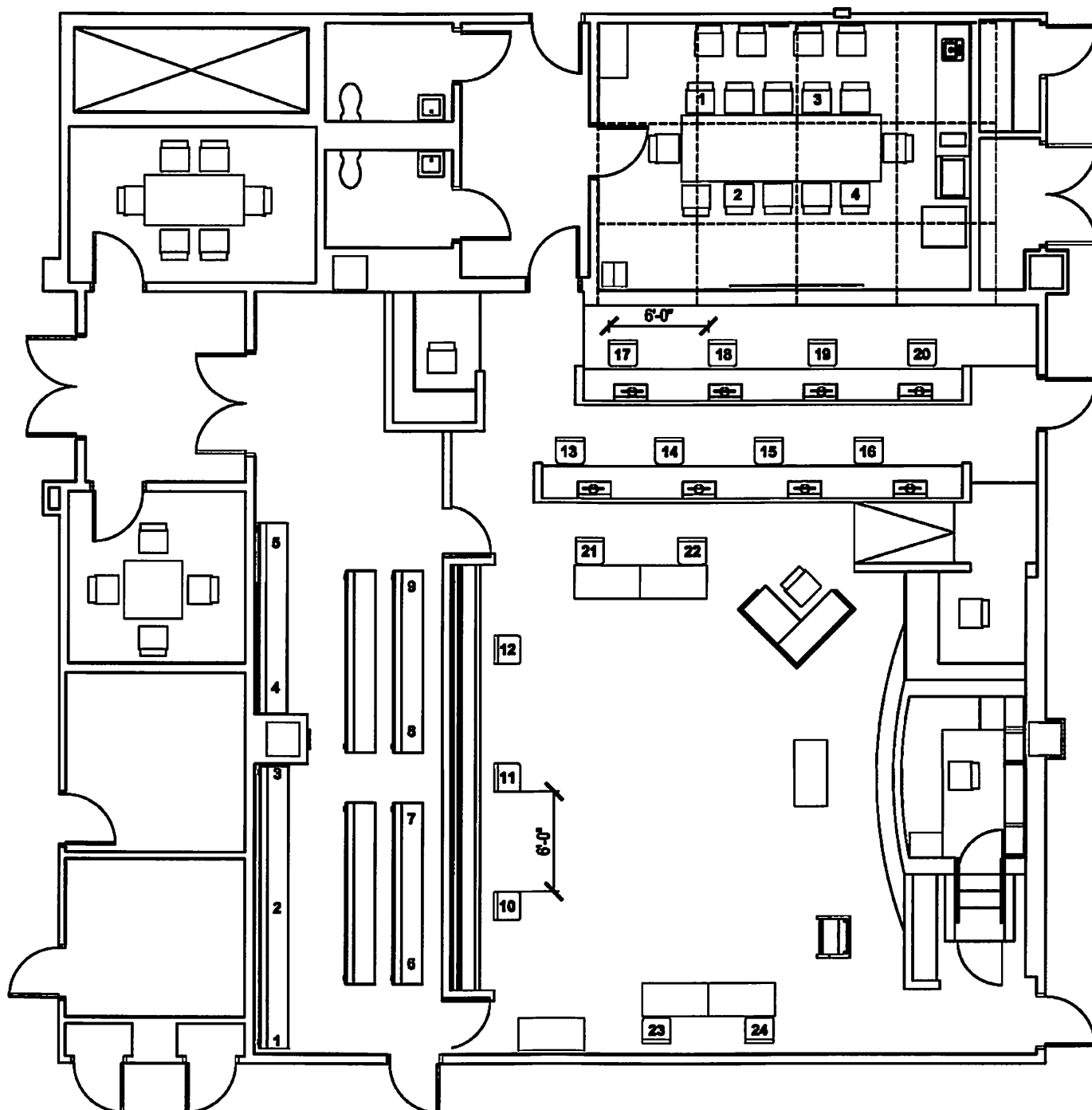

348th Dist. Ct.  
17th Dist. Ct.  
141st Dist. Ct.  
153rd Dist. Ct.

48th Dist. Ct.  
96th Dist. Ct.  
67th Dist. Ct.  
352nd Dist. Ct.

236th Dist. Ct.  
342nd Dist. Ct.

CURRENT

# FAMILY LAW CENTER

MAXIMUM SOCIAL DISTANCING OCCUPANCY LOAD IN COURTROOM IS 22

ALTERNATE #1

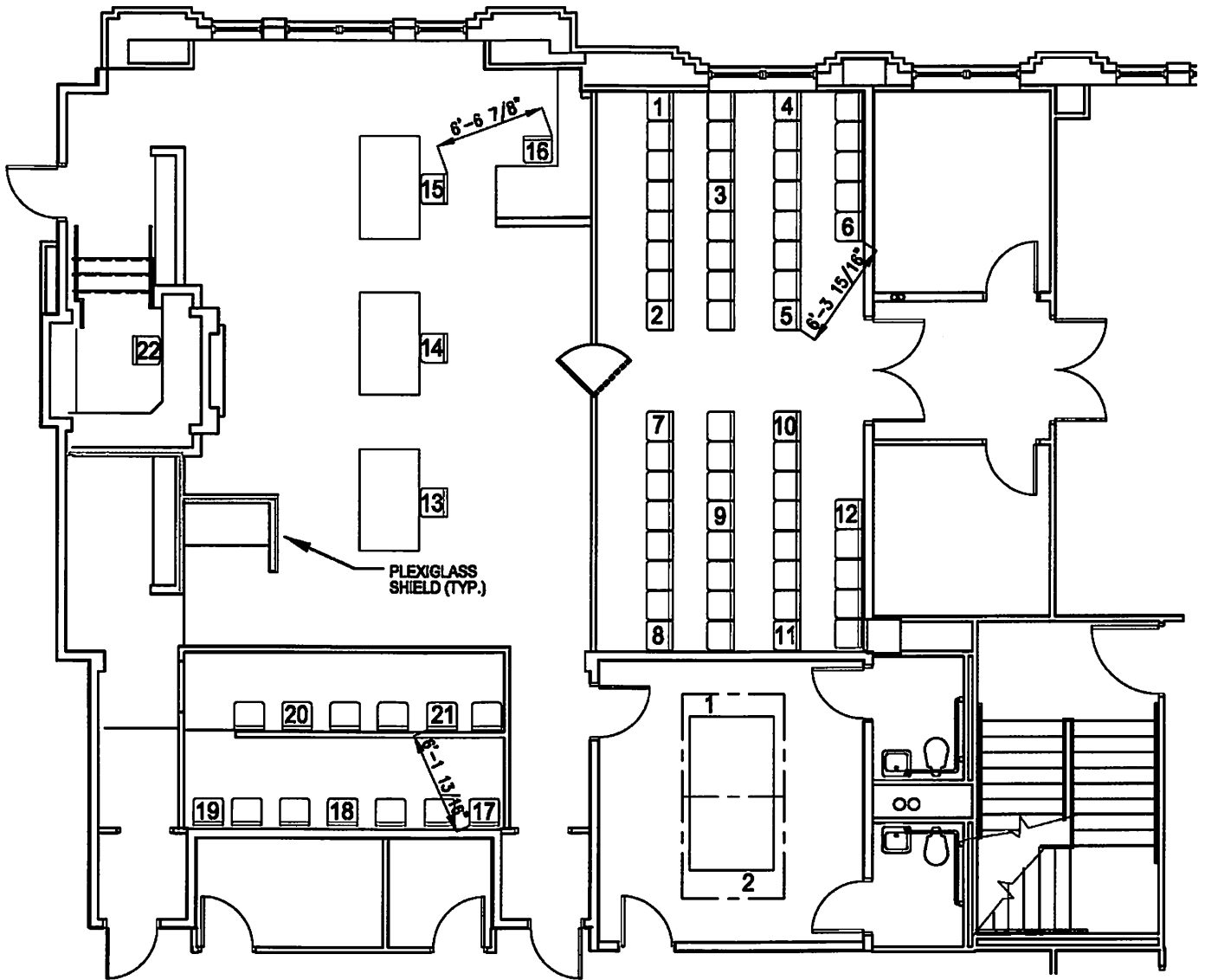

231st Dist. Court  
233rd Dist. Court  
322nd Dist. Court

324th Dist. Court  
325th Dist. Court  
360th Dist. Court

CURRENT

# FAMILY LAW CENTER

MAXIMUM SOCIAL DISTANCING OCCUPANCY LOAD IS 16

ALTERNATE #1

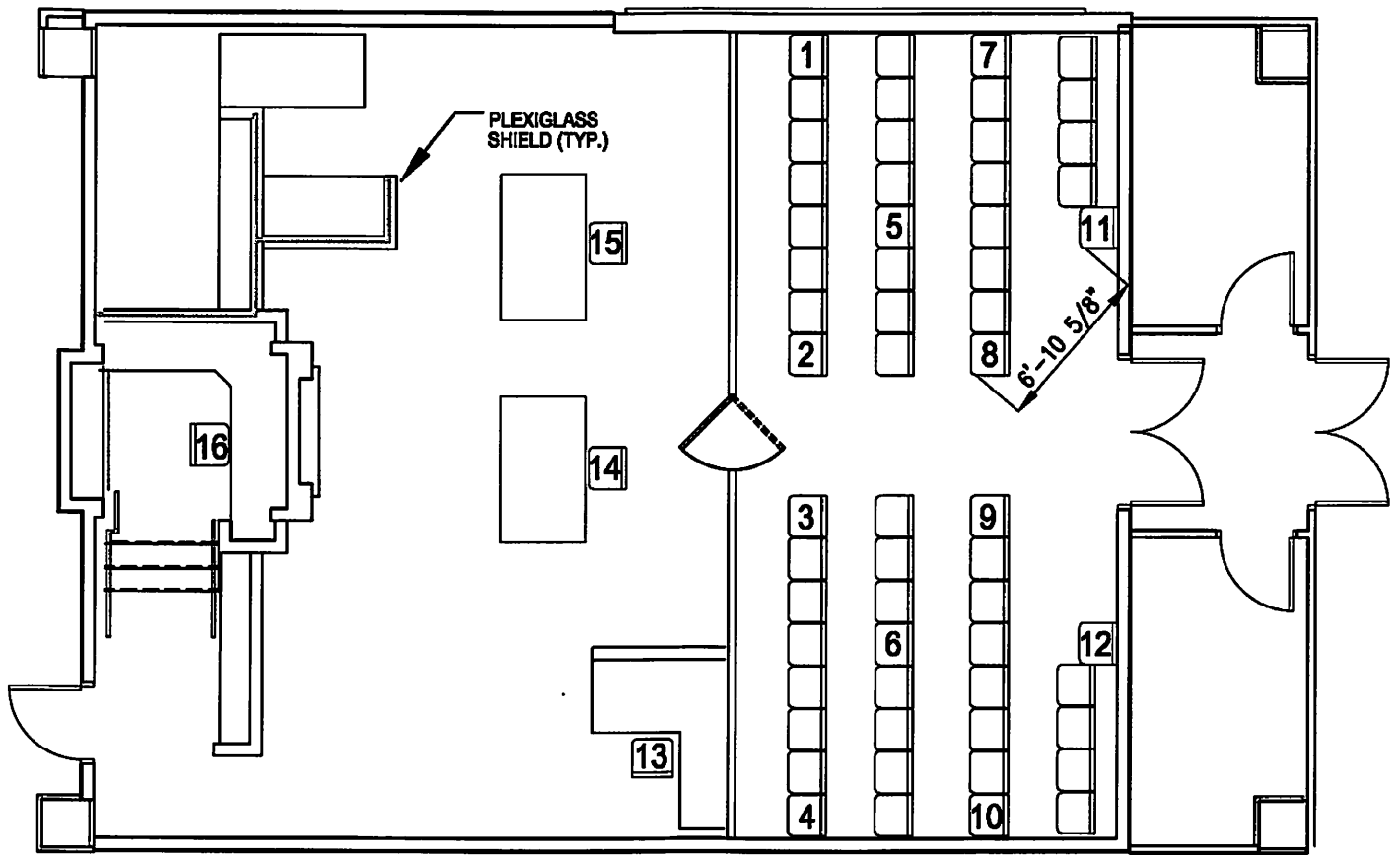

IV-D Courts  
231st Assoc. Court  
233rd Assoc. Court  
322nd Assoc. Court

324th Assoc. Court  
325th Assoc. Court  
360th Assoc. Court  
Child Protection Court

CURRENT

# FAMILY LAW CENTER

MAXIMUM SOCIAL DISTANCING OCCUPANCY LOAD IS 40

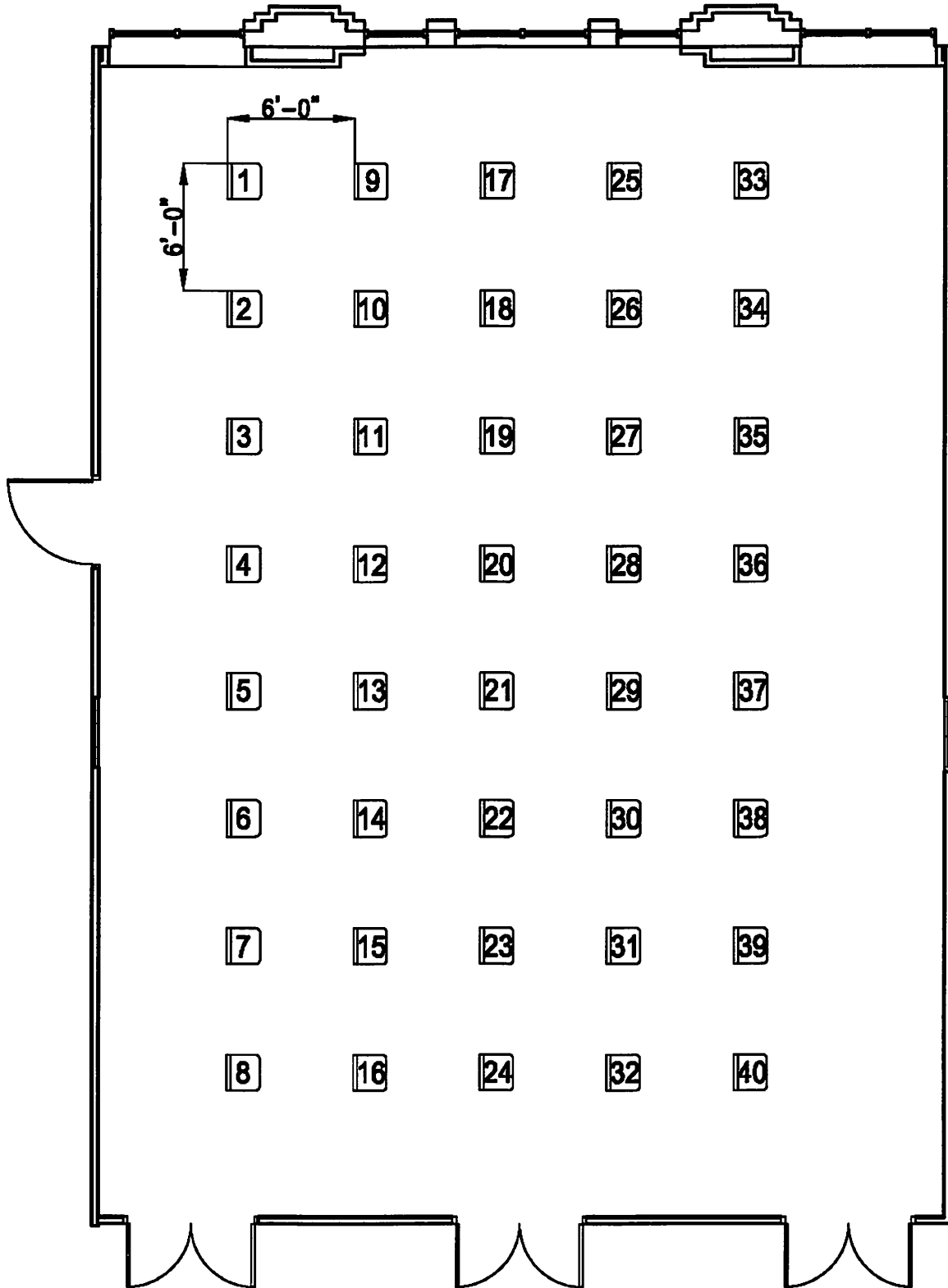

2nd Floor Assembly Room

CURRENT

# 1895 COURTHOUSE

MAXIMUM SOCIAL DISTANCING OCCUPANCY LOAD IS 15

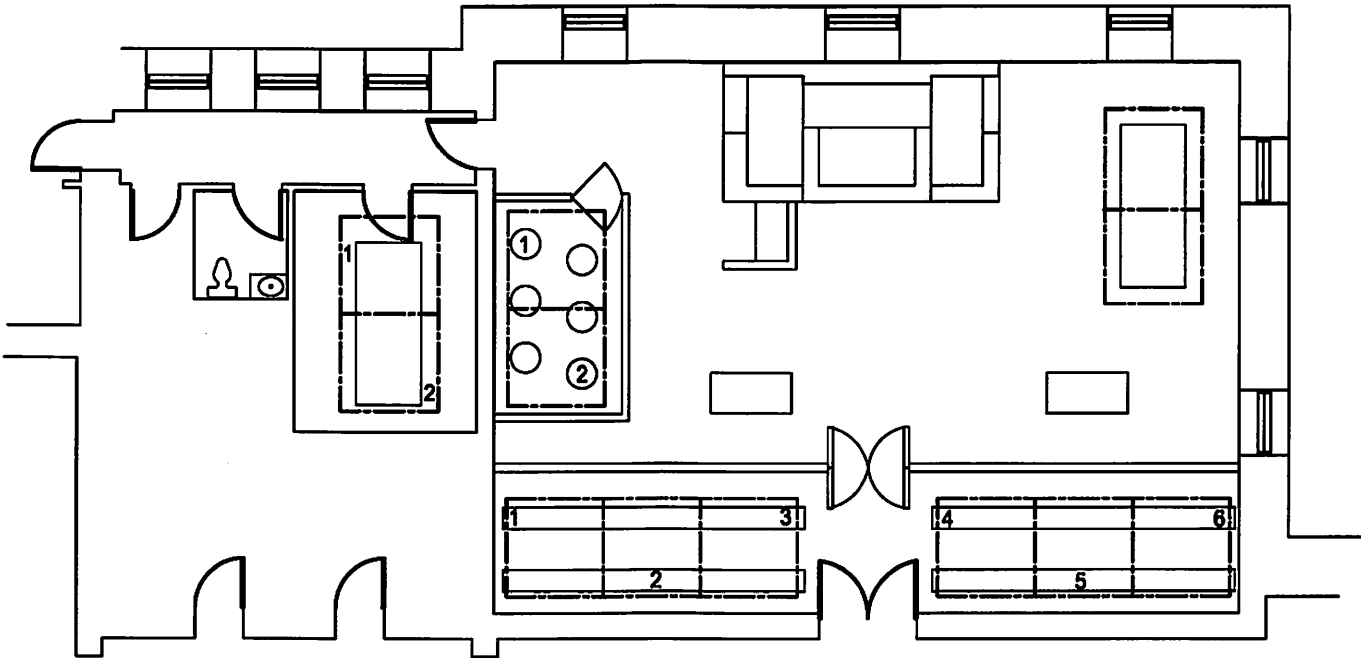

Probate Court #1  
Basement Level

CURRENT



# 1895 COURTHOUSE

MAXIMUM SOCIAL DISTANCING OCCUPANCY LOAD IS 15

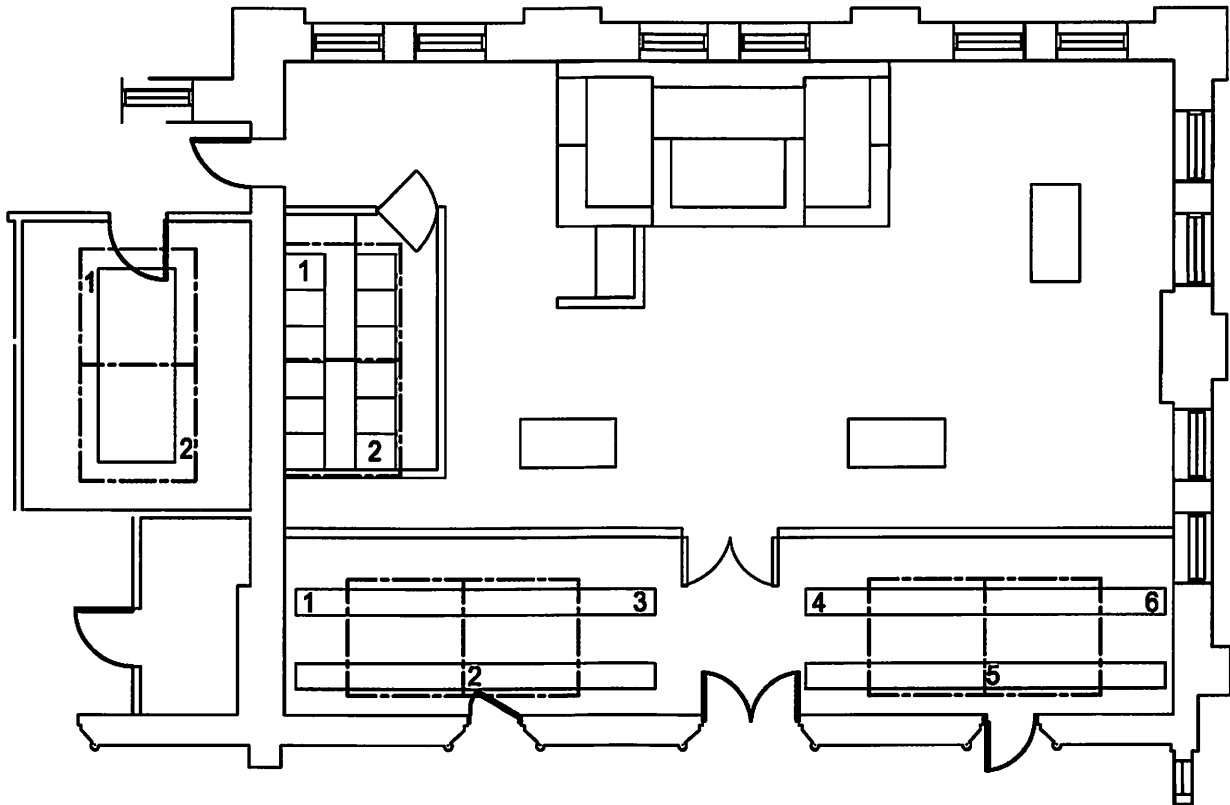

Probate Court #2  
First Floor

CURRENT

# 1895 COURTHOUSE

MAXIMUM SOCIAL DISTANCING OCCUPANCY LOAD IS 15

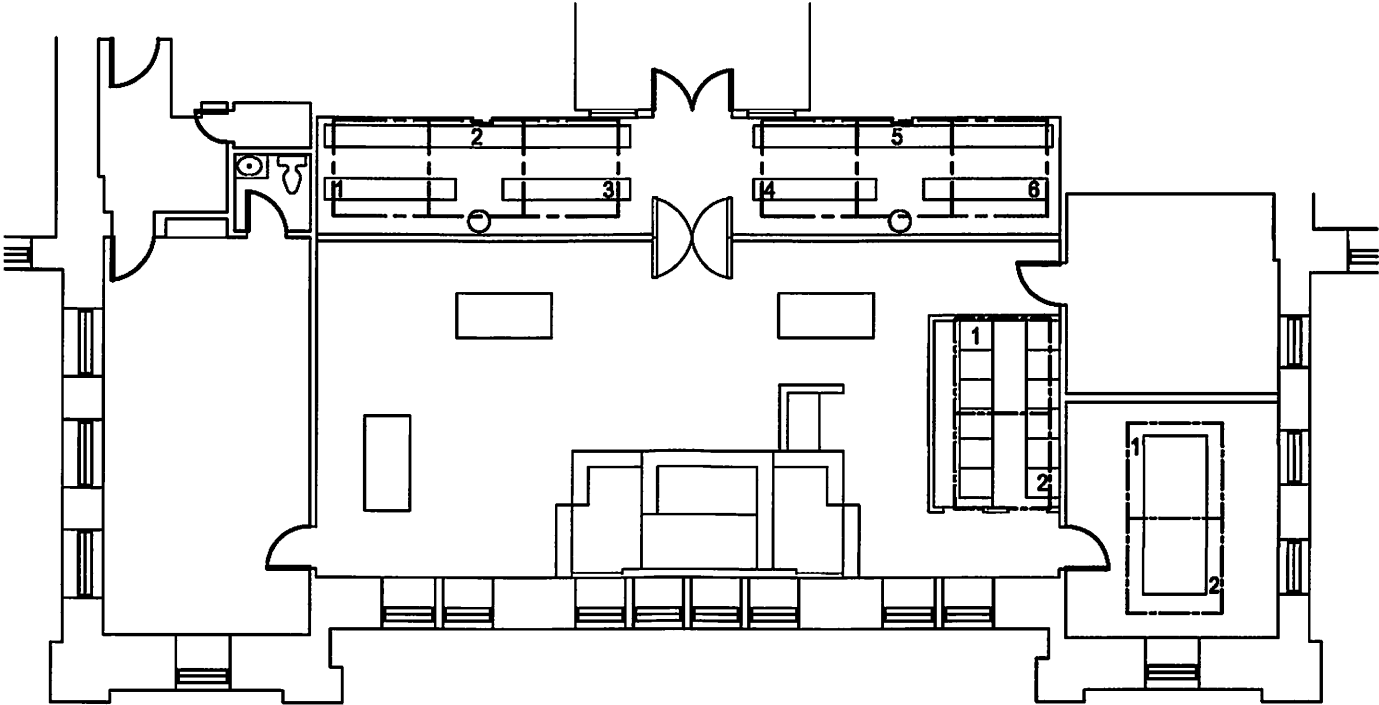

County Court at Law #3  
Second Floor

CURRENT

# 1895 COURTHOUSE

MAXIMUM SOCIAL DISTANCING OCCUPANCY LOAD IS 15

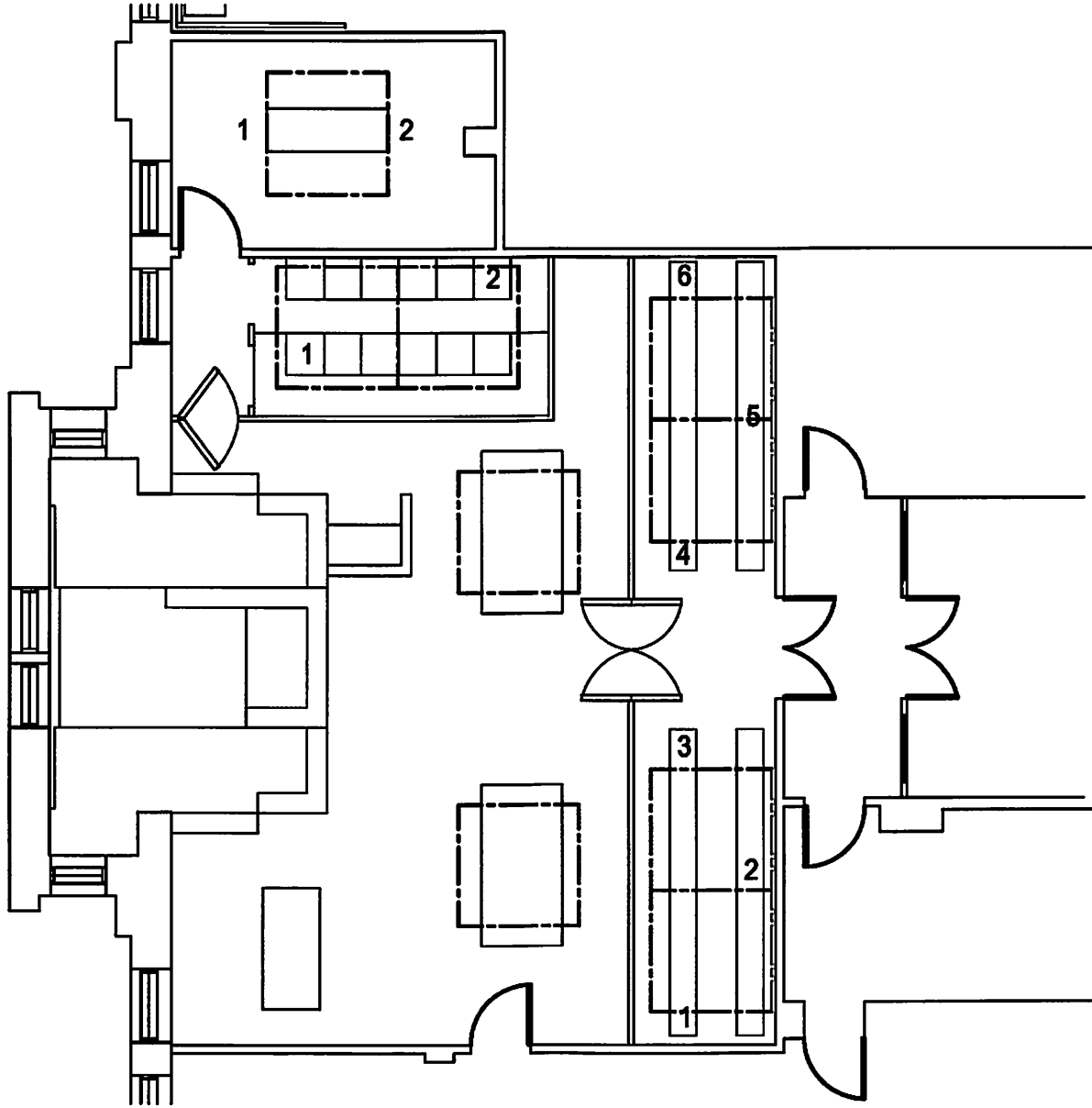

Probate Court #2  
Second Floor

CURRENT

# 1895 COURTHOUSE

MAXIMUM SOCIAL DISTANCING OCCUPANCY LOAD IS 15

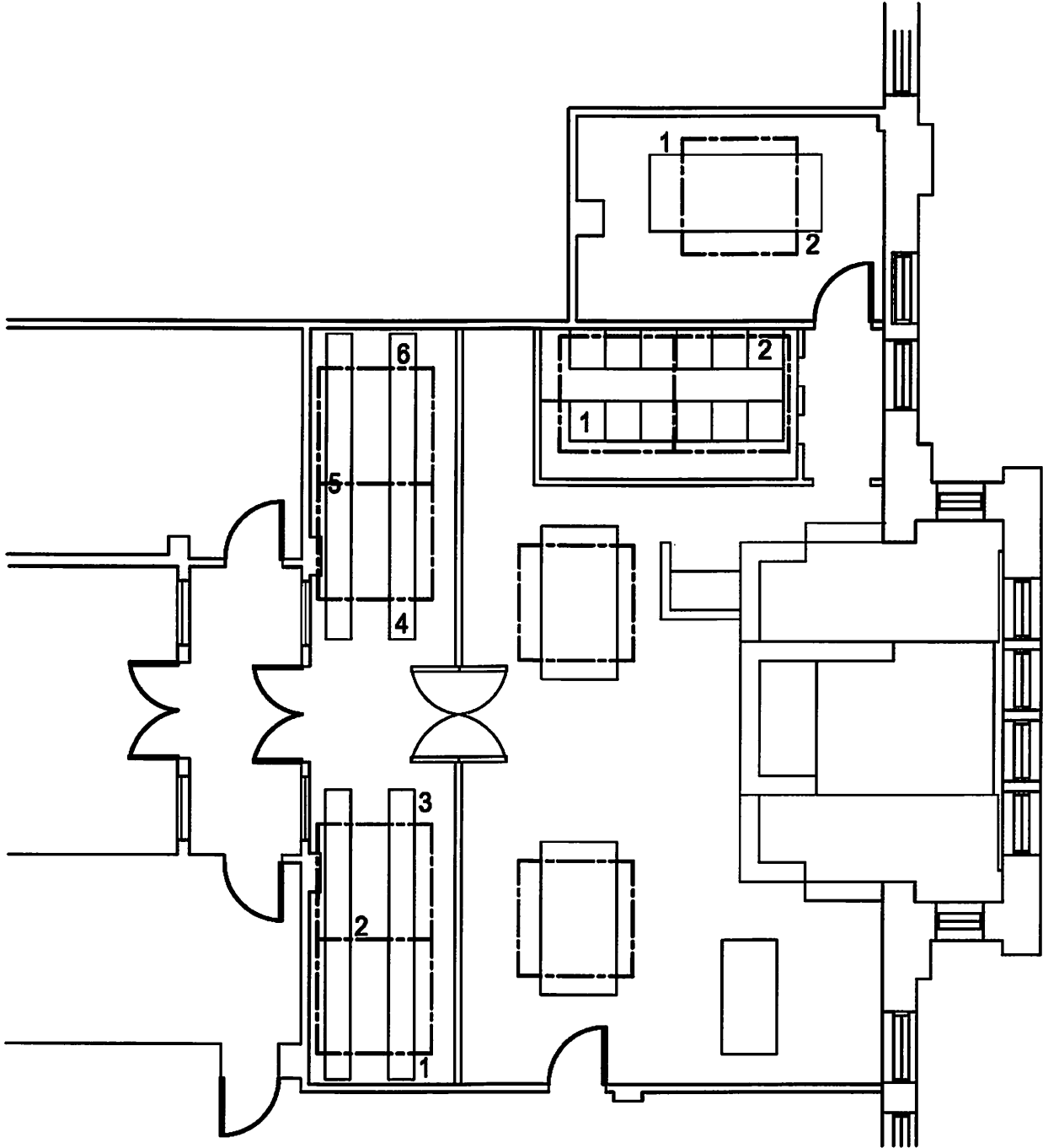

Probate Court #1  
Second Floor

CURRENT

# 1895 COURTHOUSE

MAXIMUM SOCIAL DISTANCING OCCUPANCY LOAD IS 15

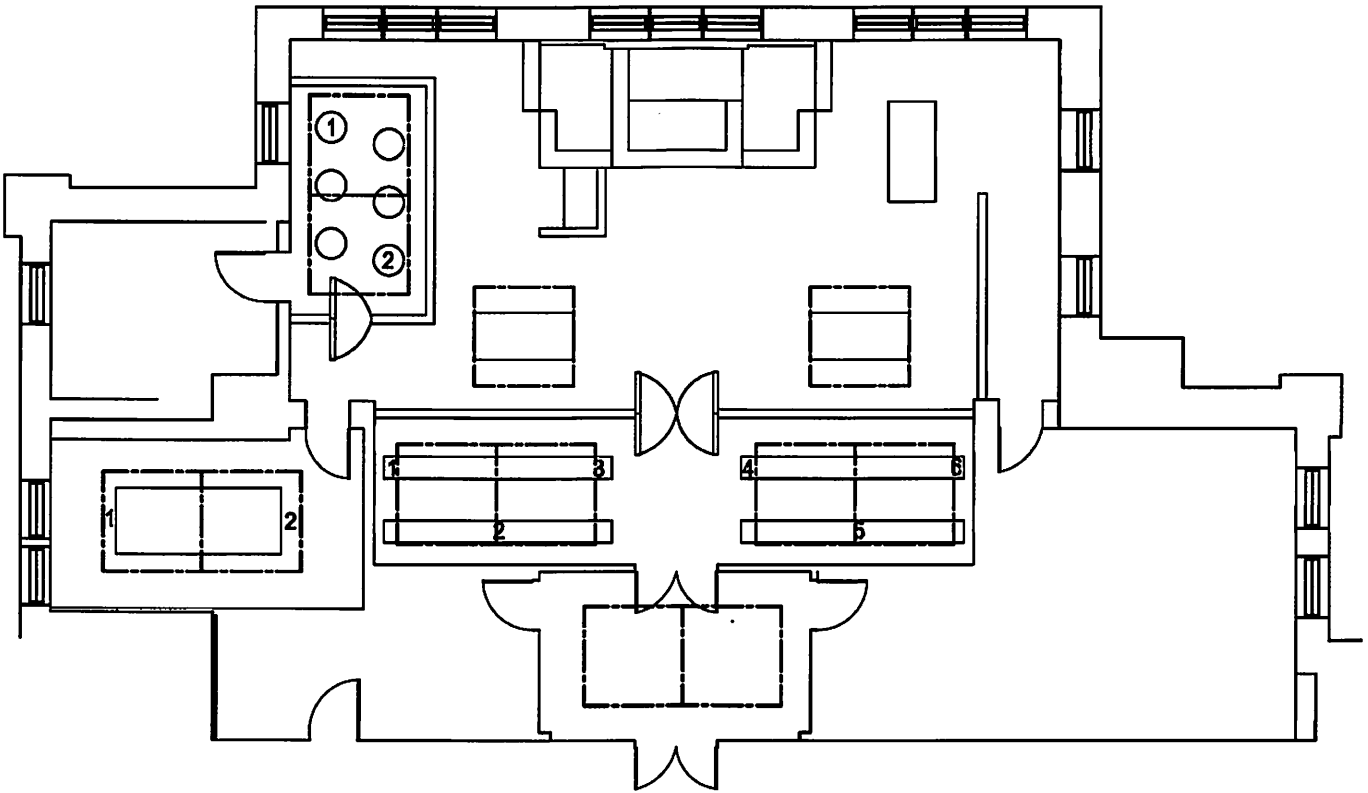

County Court at Law #2  
Second Floor

CURRENT

# 1895 COURTHOUSE

MAXIMUM SOCIAL DISTANCING OCCUPANCY LOAD IS 15

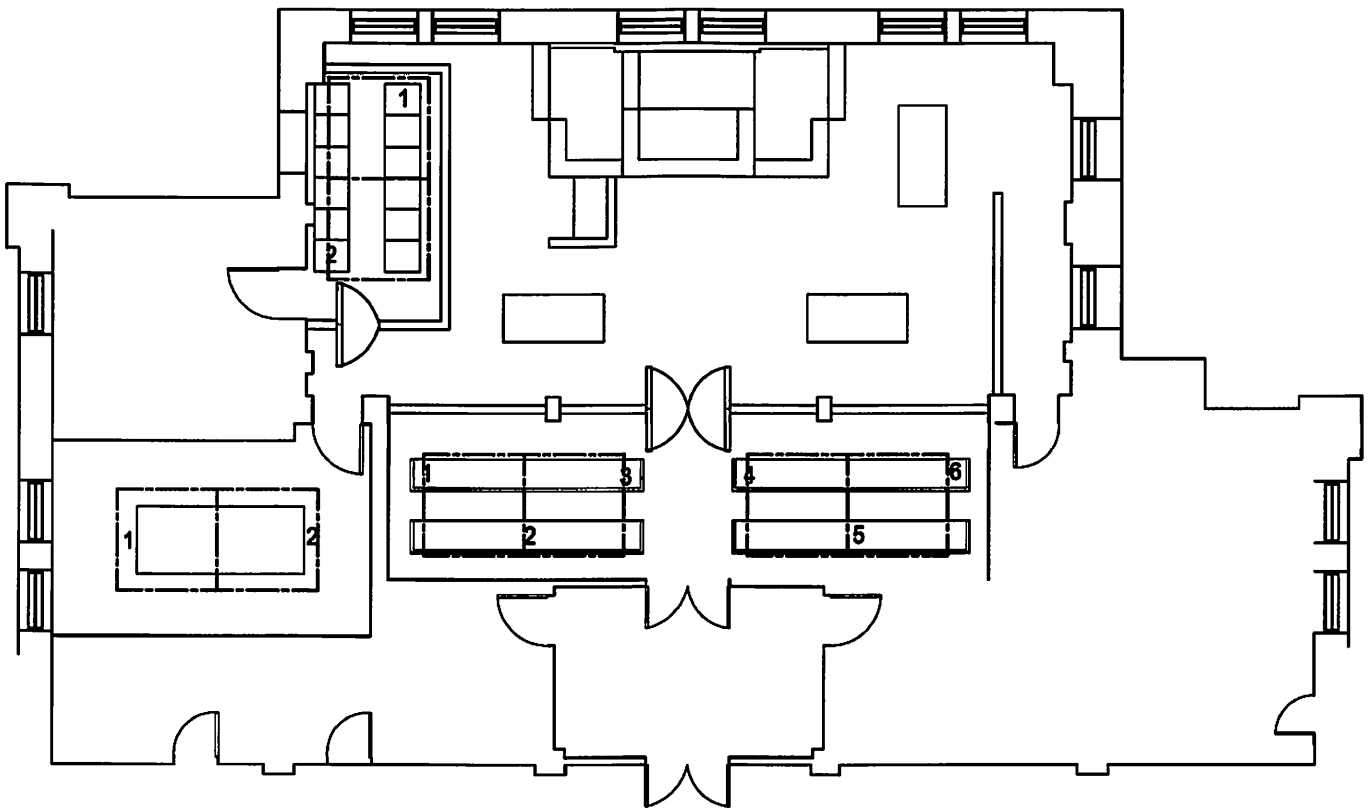

Justice of the Peace  
Fourth Floor

CURRENT

# 1895 COURTHOUSE

MAXIMUM SOCIAL DISTANCING OCCUPANCY LOAD IS 23

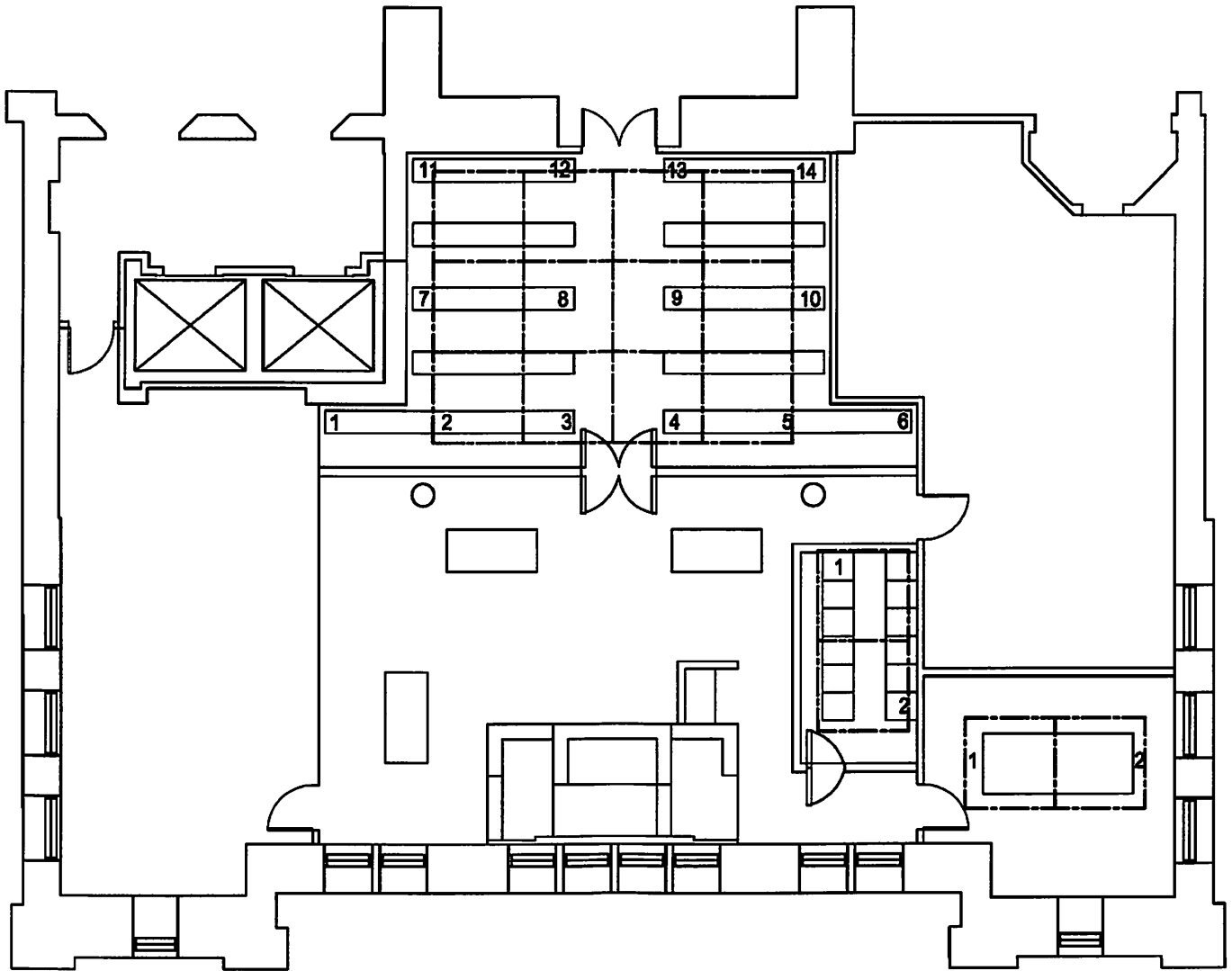

County Court at Law #1  
Fourth Floor

CURRENT

# JUVENILE JUSTICE CENTER

MAXIMUM SOCIAL DISTANCING OCCUPANCY LOAD IS 14

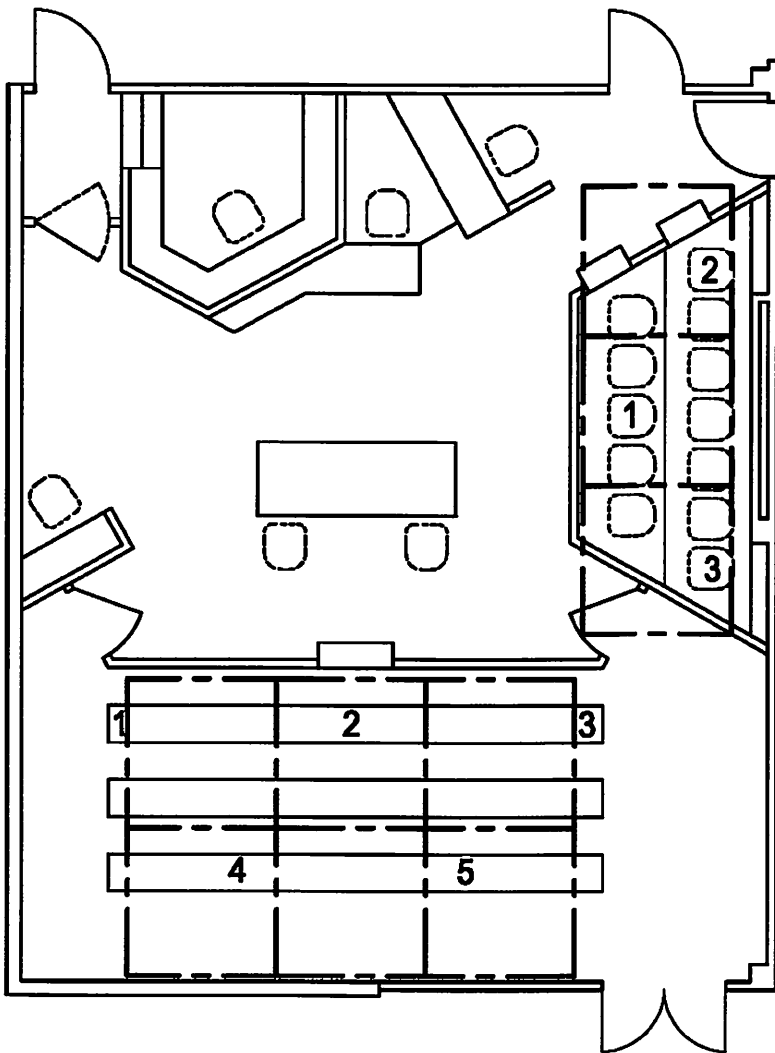

Courtroom A

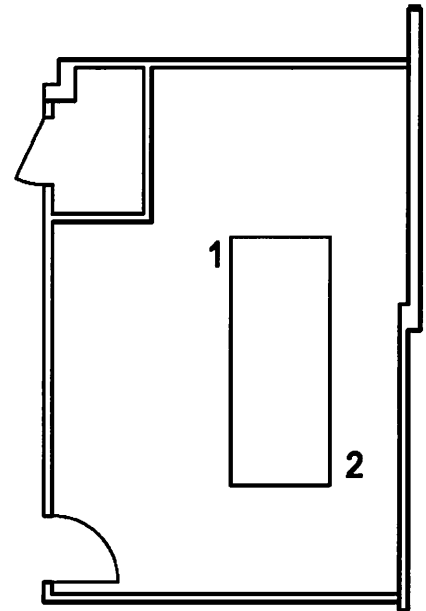

CURRENT



# JUVENILE JUSTICE CENTER

MAXIMUM SOCIAL DISTANCING OCCUPANCY LOAD IS 14

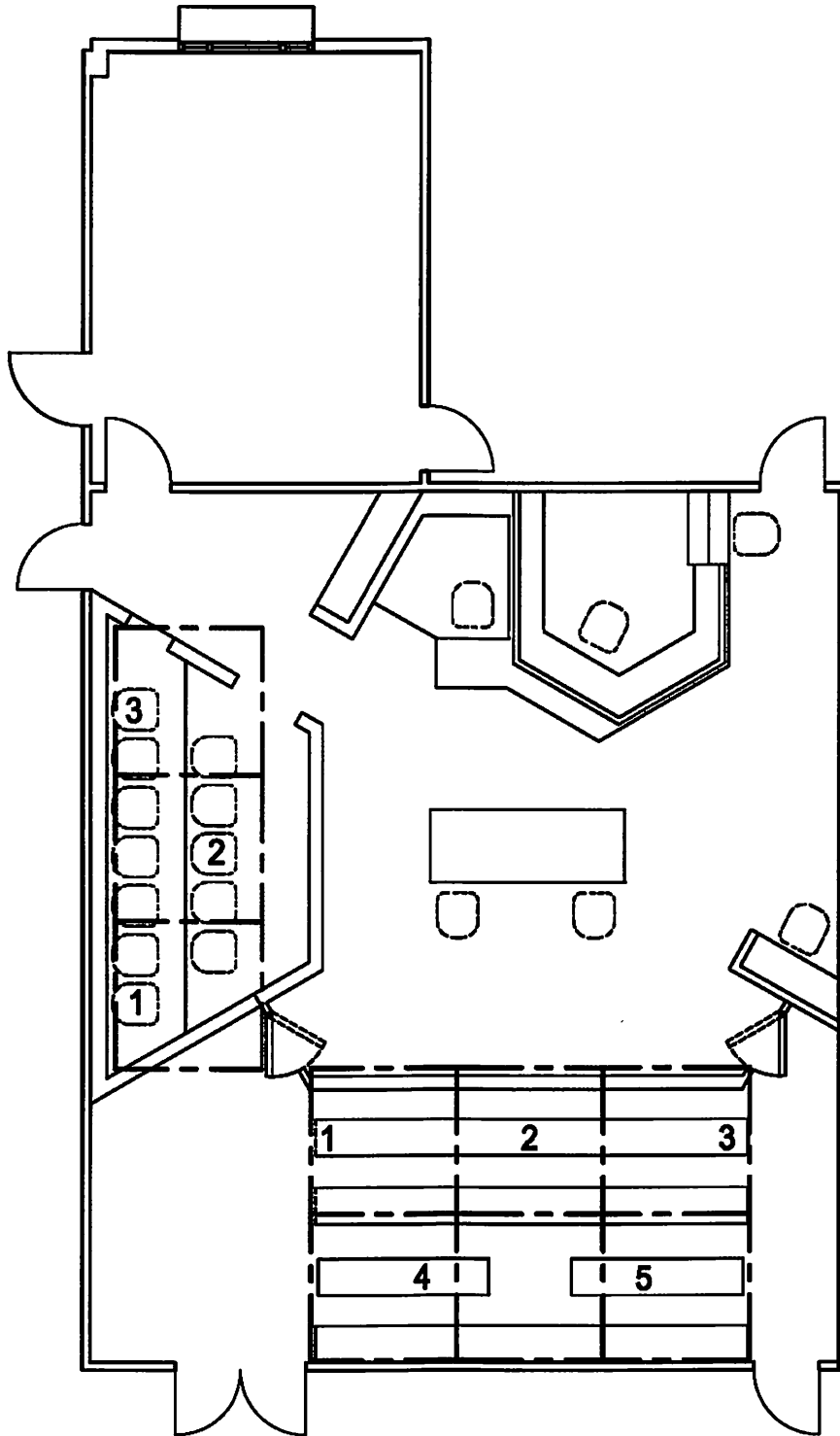

Courtroom B

CURRENT

# JUVENILE JUSTICE CENTER

MAXIMUM SOCIAL DISTANCING OCCUPANCY LOAD IS 15

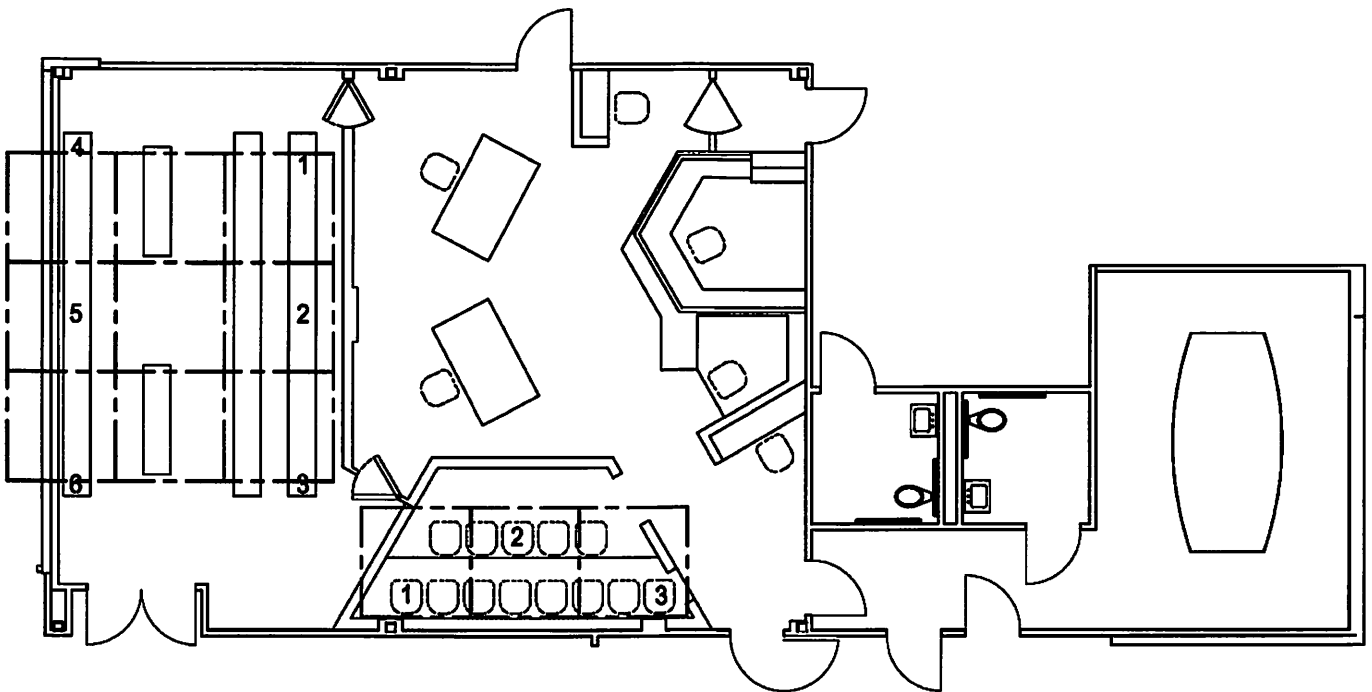

Courtroom C

CURRENT

# JUVENILE JUSTICE CENTER

MAXIMUM SOCIAL DISTANCING OCCUPANCY LOAD IS 8

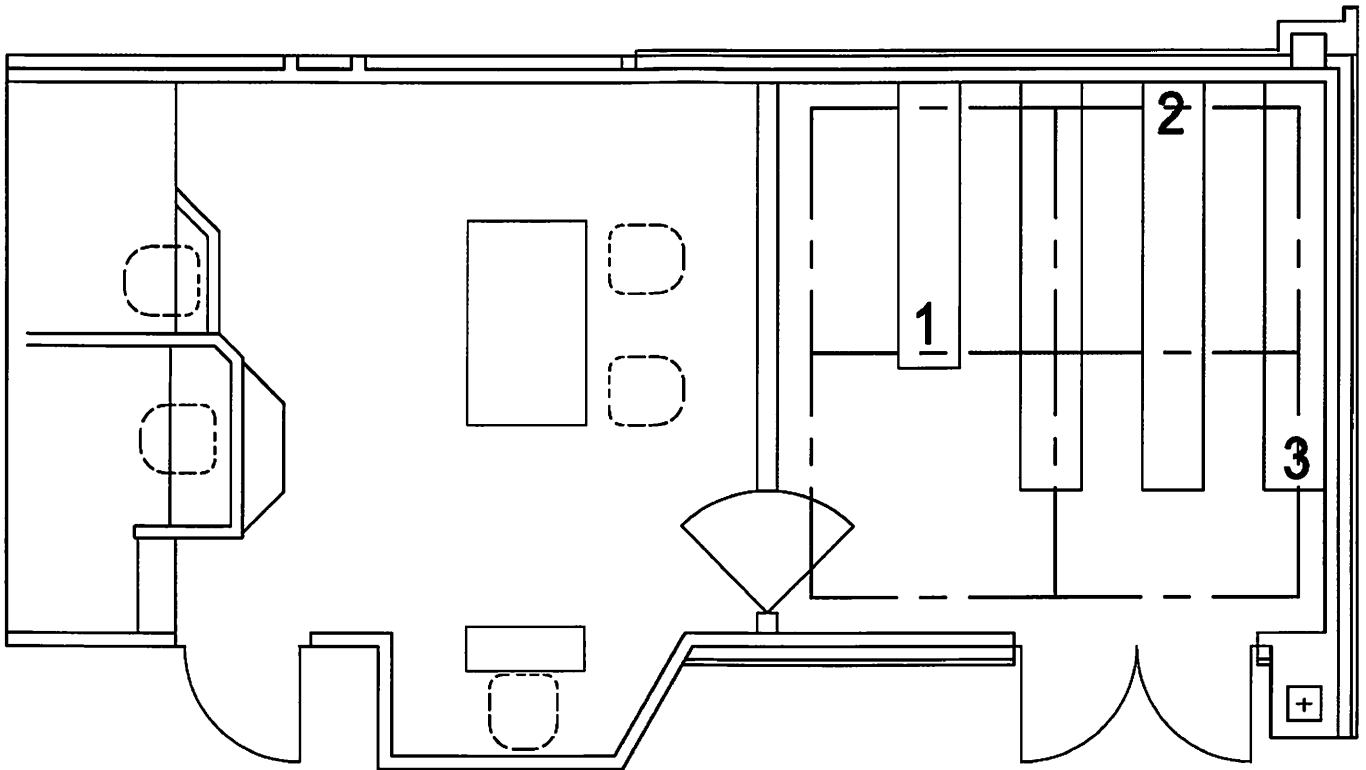

Courtroom D

CURRENT

# JUVENILE JUSTICE CENTER

MAXIMUM SOCIAL DISTANCING OCCUPANCY LOAD IS 7

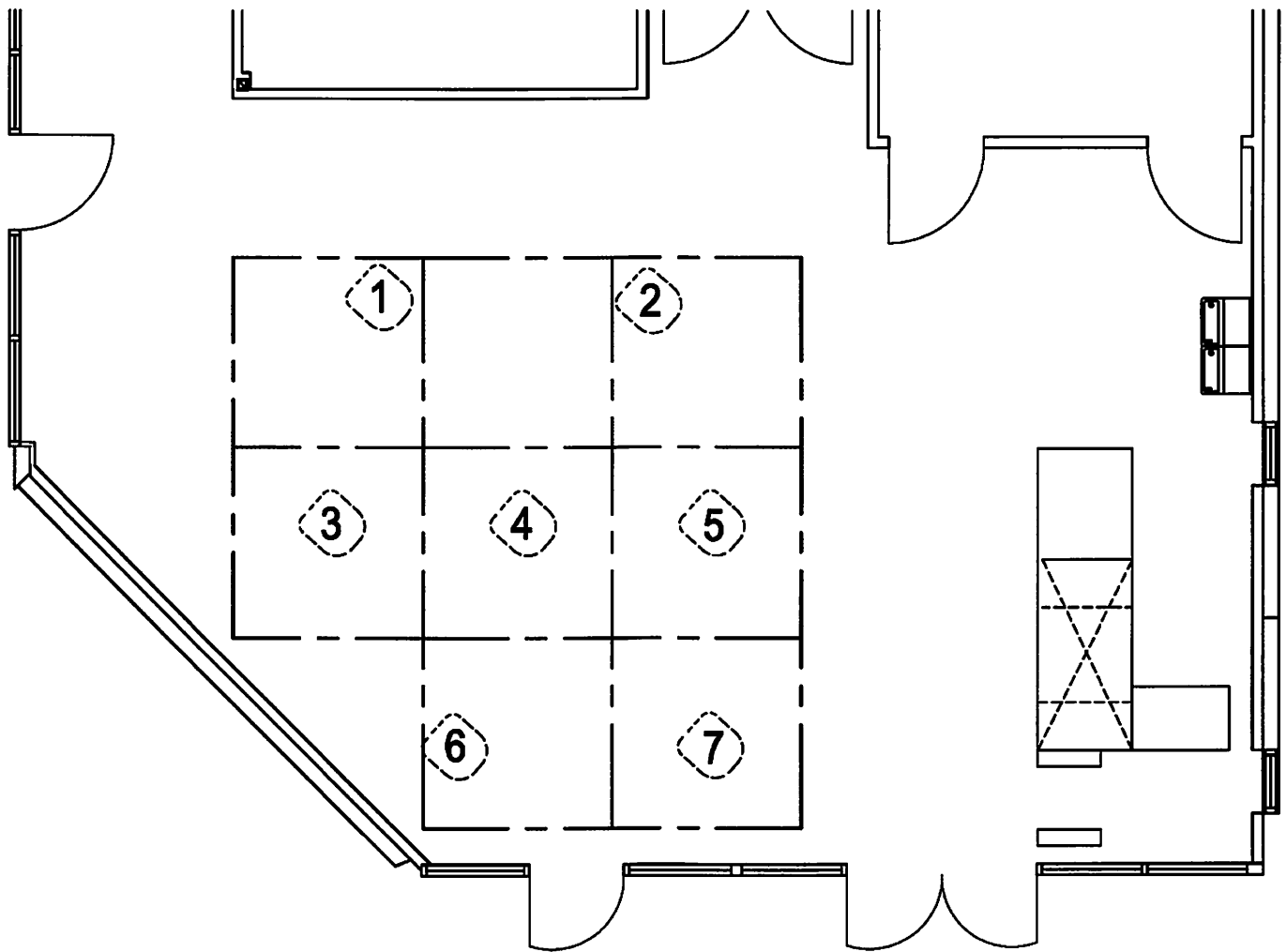

Visitation

CURRENT

# JUVENILE JUSTICE CENTER

MAXIMUM SOCIAL DISTANCING OCCUPANCY LOAD IS 30

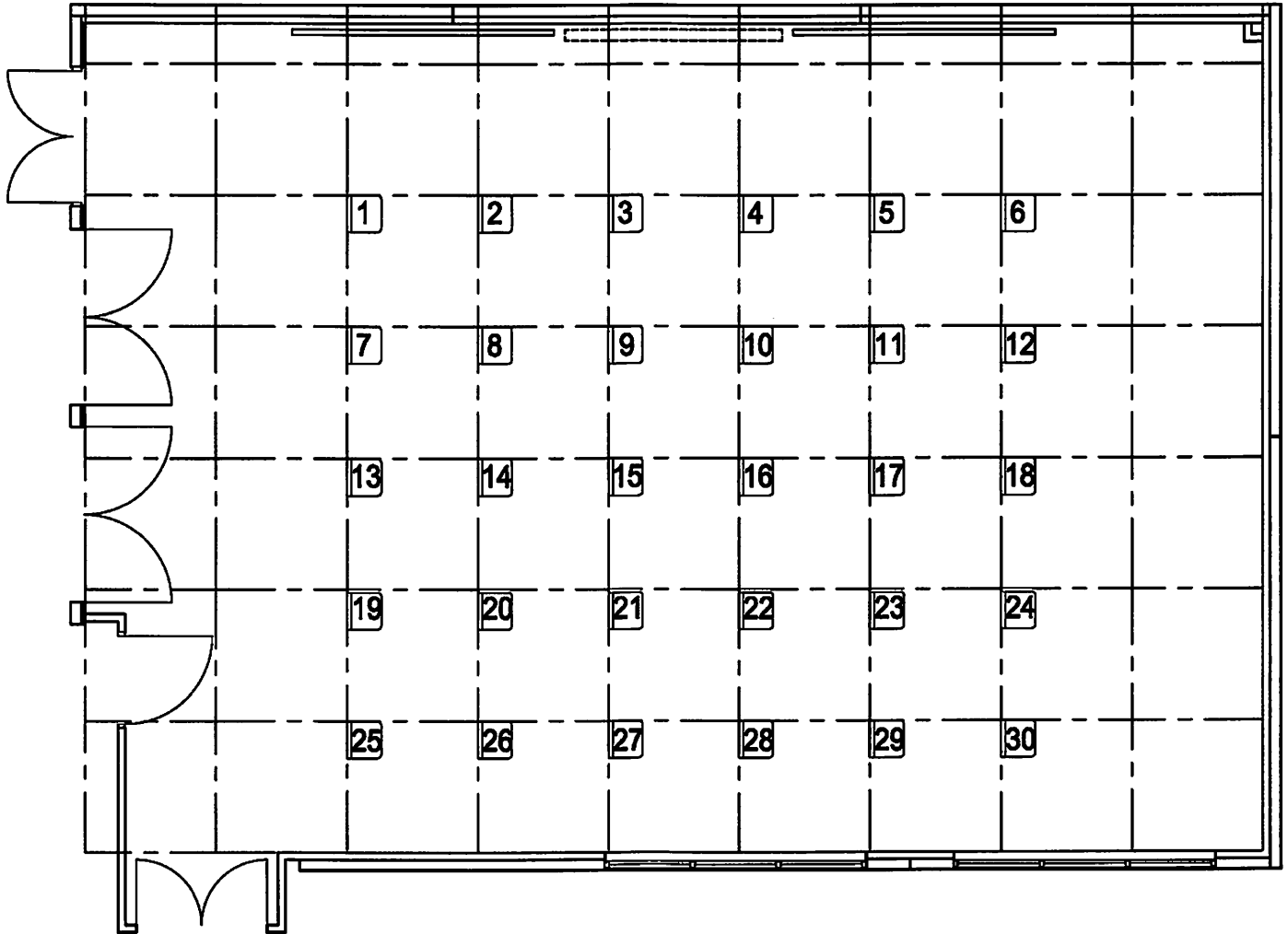

Conference Room

CURRENT

# RESOURCE CONNECTION BUILDING 2300

MAXIMUM SOCIAL DISTANCING OCCUPANCY LOAD IN GYM IS 108

